

PALETTI

PRECISE, LONG-LASTING, INDIVIDUALLY

PROTECTION AND SEPERATING WALL SYSTEMS

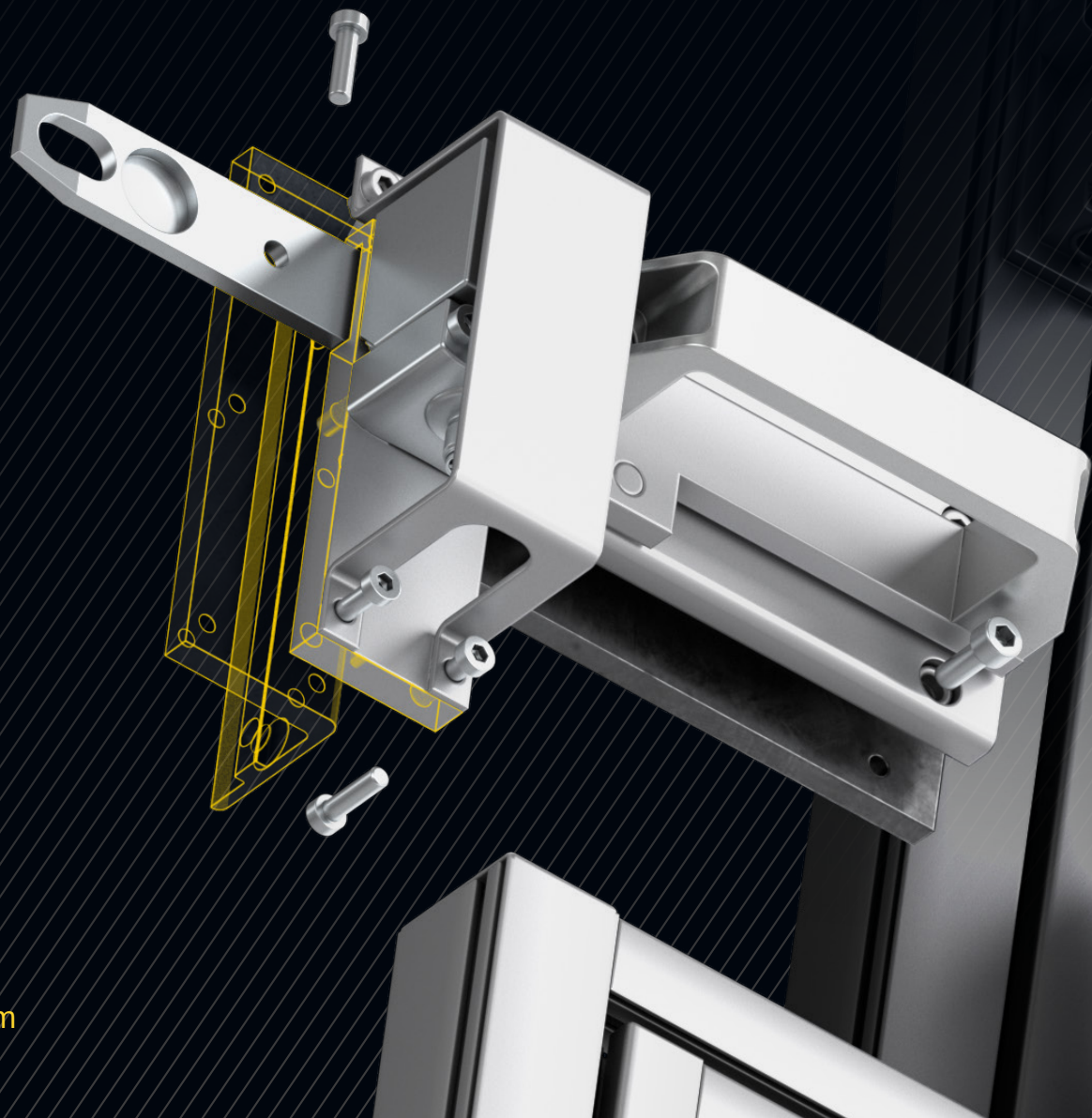

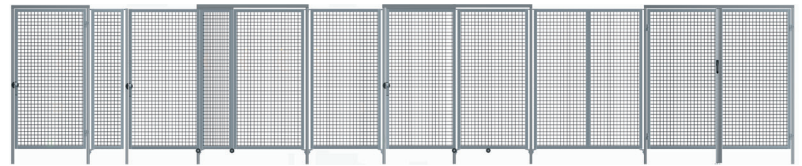

The protection and separating wall system comprises of a number of different profile families.

Standard Profiles (2 mm thru 8 mm)

From the extensive range of Silverline profiles, most static requirements can be met. Sheet materials are easily affixed using accessories from the catalogue (section E).

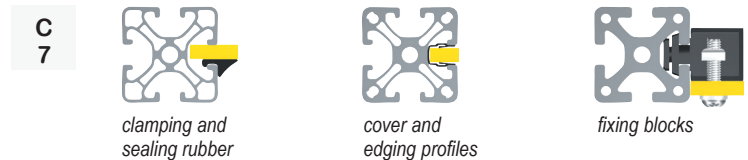

Blend Profiles (2 mm and 6 mm)

Blend profiles attach 2 mm and 6 mm sheet elements to standard profiles when pressed into the grooves.



Clamp Profiles

Clamp profiles are used for clamping sheet materials to standard profiles. In this connection an aluminum strip is pressed on the sheet material via grub screws and secures the sheet material to the profile frame. They are manufactured for all three profile ranges (40, 30, 20) in three different designs.

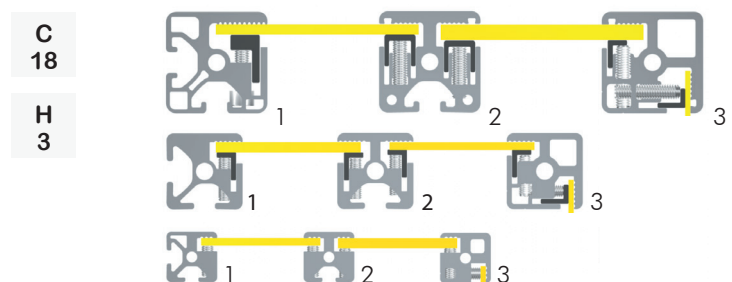

The Frame Profile (up to 8.5 mm)

The protection wall panel is assembled from frame profiles. The panel frame is made using the basic profile. The sheet element is laid into the frame and held in position by the panel profile. The left and right sides are fastened first, followed by the top and bottom. The panel profiles are comprised of a plastic and aluminum cover profile attached to a frame profile. The supplied rubber is designed to compensate for the differences in thickness of the sheet elements.



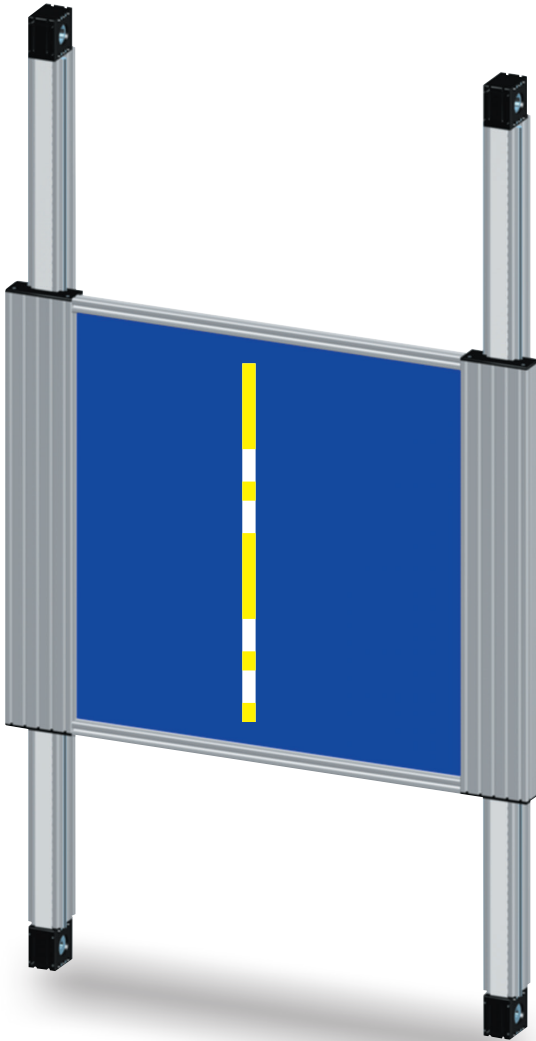

System Glider



C-Track 30 x 43, with clamp profile



C-Track 30 x 43

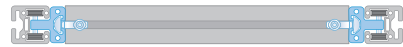

C-Track 40 x 57

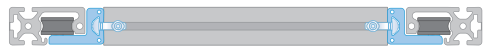

C-Track 40 x 100



C-Track 80 x 100, with two single carriages



C-Track 80 x 100 with double carriage

without counter weight – with



Linear Actuator 16 – 80 x 120 8N

Track Profiles For Vertical Lift Doors

An extensive range of vertical and horizontal sliding doors can be manufactured from the *Paletti* range of profiles and actuator accessories.

The following are a few examples showing how sliding doors are manufactured. The doors can be operated by electric motors, pneumatic cylinders or by counter balances and gas pressure dampers for ease of operation.



Clamp Profiles 40

Part No	Description	Length	Weight
SP7401N	Clamp Profile 40, complete	cut	2.25 kg / m
SP7400N3000	Clamp Profile 40, complete	3000 mm	6.75 kg
SP7400N6000	Clamp Profile 40, complete	6000 mm	13.50 kg
SP7411N	Clamp Profile 40 180°, complete	cut	2.31 kg / m
SP7410N3000	Clamp Profile 40 180°, complete	3000 mm	6.92 kg
SP7410N6000	Clamp Profile 40 180°, complete	6000 mm	13.84 kg
SP7421N	Clamp Profile 40 90°, complete	cut	2.31 kg / m
SP7420N3000	Clamp Profile 40 90°, complete	3000 mm	6.82 kg
SP7420N6000	Clamp Profile 40 90°, complete	6000 mm	13.84 kg

40

Application: Simple mounting of sheet elements and wire mesh (max. 9 mm) suitable for the construction of protective guards, doors, etc. The clamped surface material gives a highly rigid construction.

Material: aluminum, natural anodised

Supply: Complete with clamp strip and grub screws.
 • SP7401N: grub screw M6 x 16, DIN 912
 • SP7411N: grub screw M6 x 25, DIN 913

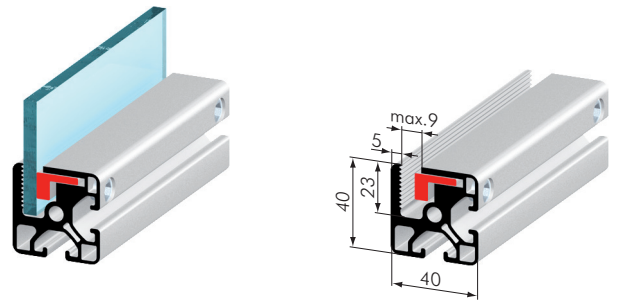

SP7401N

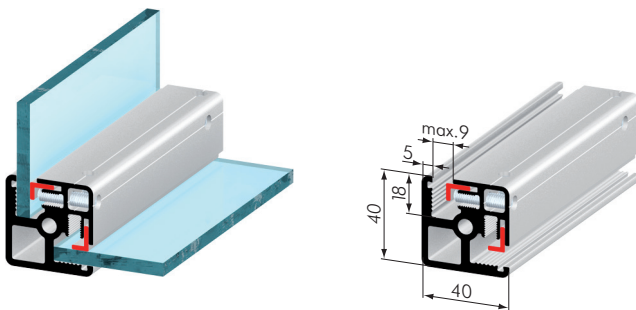

SP7421N

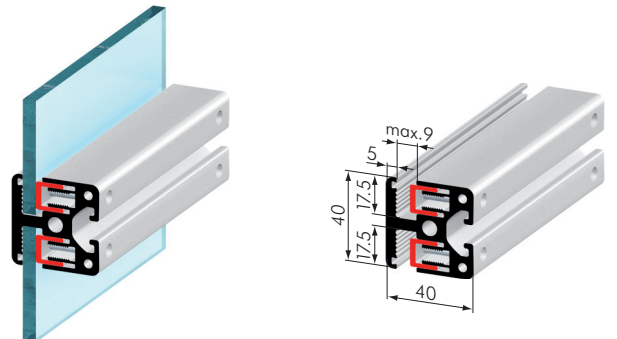

H Protection and Separating Wall Systems

4 Clamp Profiles

PALETTI

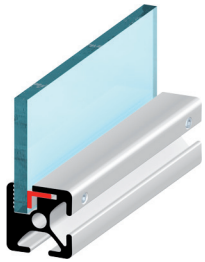

SP1571N

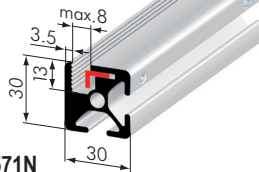

30

Clamp Profiles 30 midi

Part No	Description	Length	Weight
SP1571N	Clamp Profile 30, complete	cut	1.27 kg/m
SP1570N3000	Clamp Profile 30, complete	3000 mm	3.81 kg
SP1570N6000	Clamp Profile 30, complete	6000 mm	7.62 kg
SP1581N	Clamp Profile 30 180°, complete	cut	1.36 kg/m
SP1580N3000	Clamp Profile 30 180°, complete	3000 mm	3.98 kg
SP1580N6000	Clamp Profile 30 180°, complete	6000 mm	7.96 kg
SP1640N	Clamp Profile 30 90°, complete	cut	1.65 kg/m
SP1640N3000	Clamp Profile 30 90°, complete	3000 mm	4.95 kg
SP1640N6000	Clamp Profile 30 90°, complete	6000 mm	9.90 kg

Application: Simple mounting of sheet elements and wire mesh (max. 8 mm) suitable for the construction of protective guards, doors, etc. The clamped surface material gives a highly rigid construction.

Material: aluminum, natural anodised

Supply:

- clamp strip
- grub screws M5 x 12, DIN 913

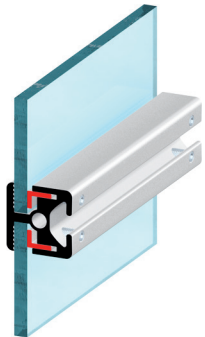

SP1581N

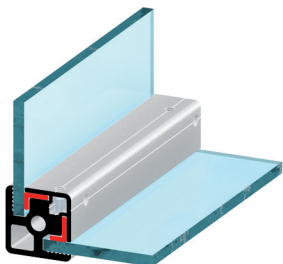
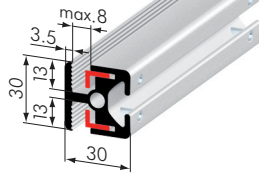

SP1641N

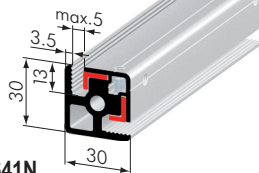

20

Clamp Profiles 20 mini

Part No	Description	Length	Weight
SP2031N	Clamp Profile 20, complete	cut	0.60 kg/m
SP2030N3000	Clamp Profile 20, complete	3000 mm	1.80 kg
SP2030N6000	Clamp Profile 20, complete	6000 mm	3.60 kg
SP2041N	Clamp Profile 20 180°, complete	cut	0.66 kg/m
SP2040N3000	Clamp Profile 20 180°, complete	3000 mm	1.98 kg
SP2040N6000	Clamp Profile 20 180°, complete	6000 mm	3.96 kg
SP2061N	Clamp Profile 20 90°, compl.	cut	0.65 kg/m
SP2060N3000	Clamp Profile 20 90°, compl.	3000 mm	1.95 kg
SP2060N6000	Clamp Profile 20 90°, compl.	6000 mm	3.90 kg

Application: Simple mounting of sheet elements and wire mesh (max. 5 mm) suitable for the construction of protective guards, doors, etc. The clamped surface material gives a highly rigid construction.

Supply:

- clamp strip
- grub screws M5 x 12, DIN 913

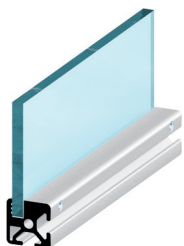

SP2031N

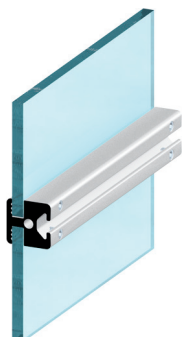
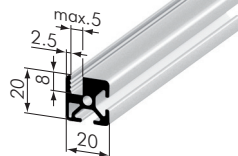

SP2041N

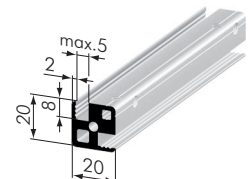
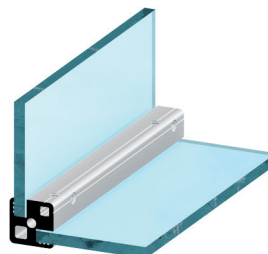
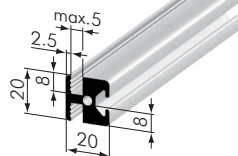

Frame Profile 40

Part No	Description	Length	Weight
SP7301N	Frame Profile 40, natural	cut	2.02 kg / m
SP7300N3000	Frame Profile 40, natural	3000 mm	6.06 kg
SP7300N6000	Frame Profile 40, natural	6000 mm	12.12 kg

Application: Simple mounting of sheet elements and wire mesh (max. 8.5 mm) suitable for the construction of protective guards, doors, etc. The clamped surface material provides high strength to the construction.

Material: aluminum, natural anodised

40

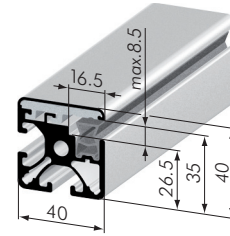

SP7301N

Blend Profile 40

Part No	Description	Length	Weight
SP0581N	Blend Profile 40 / 2 90°, natural	cut	0.40 kg / m
SP0580N3000	Blend Profile 40 / 2 90°, natural	3000 mm	1.20 kg
SP0580N6000	Blend Profile 40 / 2 90°, natural	6000 mm	2.40 kg
SP0571N	Blend Profile 40 / 2 180°, natural	cut	0.37 kg / m
SP0570N3000	Blend Profile 40 / 2 180°, natural	3000 mm	1.11 kg
SP0570N6000	Blend Profile 40 / 2 180°, natural	6000 mm	2.22 kg
SP0361N	Blend Profile 40 / 2 90°, natural	cut	0.79 kg / m
SP0360N3000	Blend Profile 40 / 2 90°, natural	3000 mm	2.37 kg
SP0360N6000	Blend Profile 40 / 2 90°, natural	6000 mm	4.74 kg
SP0521N	Blend Profile 40 / 6 90°, natural	cut	0.53 kg / m
SP0520N3000	Blend Profile 40 / 6 90°, natural	3000 mm	1.59 kg
SP0520N6000	Blend Profile 40 / 6 90°, natural	6000 mm	3.18 kg
SP0511N	Blend Profile 40 / 6 180°, natural	cut	0.43 kg / m
SP0510N3000	Blend Profile 40 / 6 180°, natural	3000 mm	1.29 kg
SP0510N6000	Blend Profile 40 / 6 180°, natural	6000 mm	2.58 kg

Application: To fix panels (2 mm or 6 mm).

Material: aluminum, natural anodised

40

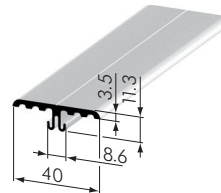

SP0571N

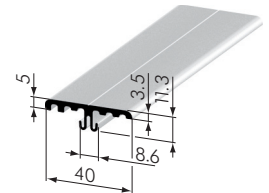

SP0581N

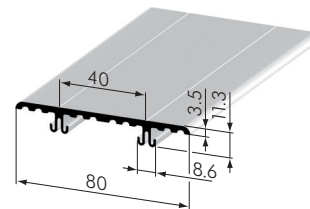

SP0361N

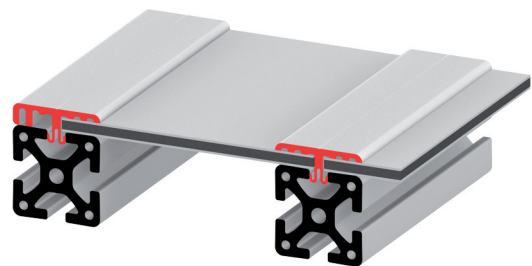
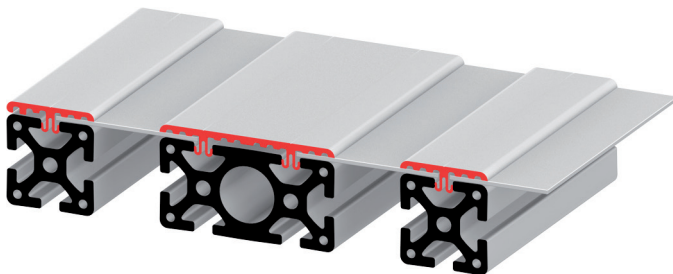
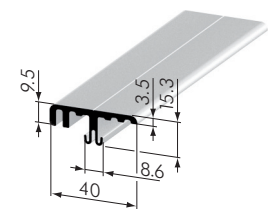
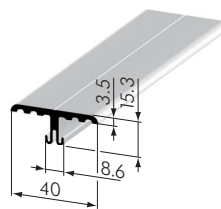

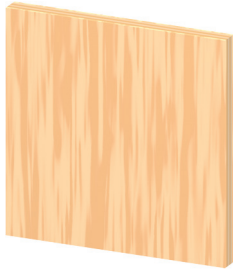

SZ1680H

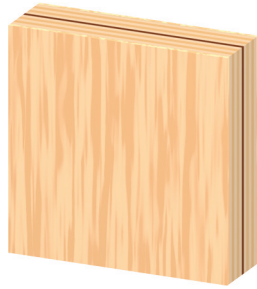

SZ1685H

Beech Plywood		
Part No	Description	Weight
SZ1680H	Beech Plywood 8	5.9 kg / m ²
SZ1685H	Beech Plywood 30	22.1 kg / m ²

Application: Suitable for workshops and laboratory benches.

maximum size: 2500 mm x 1500 mm

Material: beech, natural



SZ1602K



SZ1602R



SZ1603K



SZ1603R



SZ1604K



SZ1604R



SZ1605K



SZ1605R

Polycarbonate		
Part No	Description	Weight
SZ1602K	Polycarbonate 4 mm, clear	4.8 kg / m ²
SZ1602R	Polycarbonate 4 mm, smoked	4.8 kg / m ²
SZ1603K	Polycarbonate 5 mm, clear	6.0 kg / m ²
SZ1603R	Polycarbonate 5 mm, smoked	6.0 kg / m ²
SZ1604K	Polycarbonate 6 mm, clear	7.2 kg / m ²
SZ1604R	Polycarbonate 6 mm, smoked	7.2 kg / m ²
SZ1605K	Polycarbonate 8 mm, clear	9.6 kg / m ²
SZ1605R	Polycarbonate 8 mm, smoked	9.6 kg / m ²

Application: Sheet materials for protective walls and separator applications.

maximum size: 3050 mm x 2050 mm

Material: Makrolon

Accessories:

- SZ1901S sealing rubber 40 4 mm
- SZ1900S sealing rubber 40 6 mm
- SZ1510S fixing block 40 Vario

- SZ1903S sealing rubber 30 4 mm
- SZ1902S sealing rubber 30 6 mm
- SZ1540S fixing block 30 Vario

Plexiglass		
Part No	Description	Weight
SZ1622K	Plexiglass 4 mm, clear	4.8 kg / m ²
SZ1623K	Plexiglass 5 mm, clear	6.0 kg / m ²

Application: Sheet materials for protective walls and separator applications.

maximum size: 3050 mm x 2050 mm



SZ1622K



SZ1623K

Plexiglass		
Part No	Description	Weight
SZ1622R	Plexiglass 4 mm, smoked	4.8 kg / m ²
SZ1623R	Plexiglass 5 mm, smoked	6.0 kg / m ²
SZ1624K	Plexiglass 6 mm, clear	7.2 kg / m ²
SZ1624R	Plexiglass 6 mm, smoked	7.2 kg / m ²
SZ1625K	Plexiglass 8 mm, clear	9.6 kg / m ²
SZ1625R	Plexiglass 8 mm, smoked	9.6 kg / m ²

Application: Sheet materials for protective walls and separator applications.

maximum size: 3050 mm x 2050 mm

Material: Plexiglass

- Accessories:**
- SZ1901S sealing rubber 40 4 mm
 - SZ1900S sealing rubber 40 6 mm
 - SZ1510S fixing block 40 Vario
 - SZ1903S sealing rubber 30 4 mm
 - SZ1902S sealing rubber 30 6 mm
 - SZ1540S fixing block 30 Vario



SZ1622R



SZ1623R



SZ1624K



SZ1624R



SZ1625K



SZ1625R

Aluminum Laminated Material (Alucobond®)		
Part No	Description	Weight
SZ1650N	Aluminum Laminated Material 4 mm	5.49 kg / m ²
SZ1651N	Aluminum Laminated Material 6 mm	7.29 kg / m ²

Application: Suitable for workshops and laboratory benches. These surface elements comprise of two anodized aluminum cover plates that are permanently bonded by a polyethylene plate.

maximum size: 3000 mm x 1500 mm

Material: Alucobond® (aluminum laminated material)

- Accessories:**
- SZ1901S sealing rubber 40 4 mm
 - SZ1900S sealing rubber 40 6 mm
 - SZ1510S fixing block 40 Vario
 - SZ1903S sealing rubber 30 4 mm
 - SZ1902S sealing rubber 30 6 mm
 - SZ1540S fixing block 30 Vario



SZ1650N

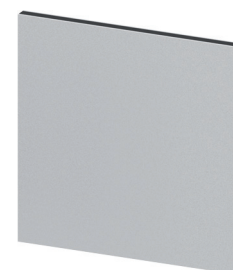

SZ1651N

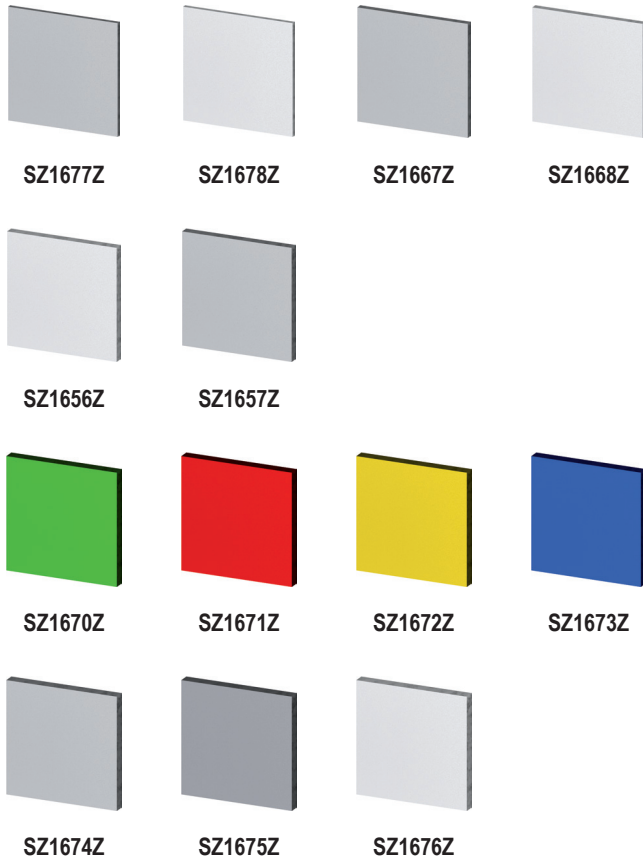

- white similar to RAL 9016
- light grey similar to RAL 7030
- grey similar to RAL 7035

- green similar to RAL 6011
- red similar to RAL 3000
- yellow similar to RAL 1034
- blue similar to RAL 5024

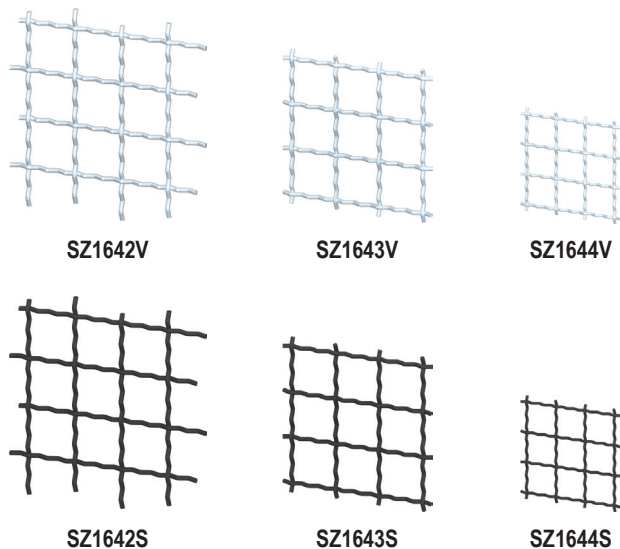

Cellulose		
Part No	Description	Weight
SZ1677Z	Cellulose 4 mm, light grey	5.8 kg / m ²
SZ1678Z	Cellulose 4 mm, white	5.8 kg / m ²
SZ1667Z	Cellulose 6 mm, light grey	8.8 kg / m ²
SZ1668Z	Cellulose 6 mm, white	8.8 kg / m ²
SZ1656Z	Cellulose 8 mm, white	11.6 kg / m ²
SZ1657Z	Cellulose 8 mm, light grey	11.6 kg / m ²
SZ1670Z	Cellulose 10 mm, green	14.6 kg / m ²
SZ1671Z	Cellulose 10 mm, red	14.6 kg / m ²
SZ1672Z	Cellulose 10 mm, yellow	14.6 kg / m ²
SZ1673Z	Cellulose 10 mm, blue	14.6 kg / m ²
SZ1674Z	Cellulose 10 mm, light grey	14.6 kg / m ²
SZ1675Z	Cellulose 10 mm, grey	14.6 kg / m ²
SZ1676Z	Cellulose 10 mm, white	14.6 kg / m ²

Application: For highly stressed surfaces and panelling. Drilling and tapping in this material is possible. Resin bonded cellulose, hot pressed. Double sided surface coating. Further gauges and colours on request.

maximum size: 2750 mm x 2020 mm

Material: cellulose

- Accessories:**
- SZ1901S sealing rubber 40 4 mm
 - SZ1900S sealing rubber 40 6 mm
 - SZ1510S fixing block 40 Vario

- SZ1903S sealing rubber 30 4 mm
- SZ1902S sealing rubber 30 6 mm
- SZ1540S fixing block 30 Vario

Mesh Steel		
Part No	Description	Weight
SZ1642V	Mesh 4 x 40 Steel, natural	4.23 kg / m ²
SZ1642S	Mesh 4 x 40 Steel, black	4.23 kg / m ²
SZ1643V	Mesh 3 x 30 Steel, natural	3.78 kg / m ²
SZ1643S	Mesh 3 x 30 Steel, black	3.78 kg / m ²
SZ1644V	Mesh 2 x 20 Steel, natural	2.15 kg / m ²
SZ1644S	Mesh 2 x 20 Steel, black	2.15 kg / m ²

Application: Sheet materials for protective walls and separator applications.

maximum size: 3000 mm x 2000 mm

Material: steel, natural or black

- Accessories:**
- mesh profiles 40
 - clamp profiles 30 complete
 - clamp profiles 20 complete

Weld Meshes

Part No	Description	Weight
SZ1645V	Weld Mesh 4 x 40, zinc-plated	
SZ1645S	Weld Mesh 4 x 40, black	

Application: Welded wire mesh used for doors, protective walls, and partitions.

maximum size: 3000 mm x 1500 mm

Material: steel, zink-plated

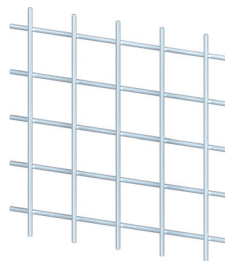

SZ1645V

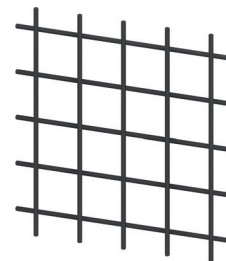

SZ1645S

Aluminum Sheets

Part No	Description	Weight
SZ1660G	Aluminum Sheet 2 mm	5.4 kg / m ²
SZ1662G	Aluminum Sheet 4 mm	10.8 kg / m ²

Application: The panel can be supplied in a variety of colours. The colour must be advised at time of order.

maximum size: SZ1660G: 3000 mm x 1500 mm
SZ1662G: 2500 mm x 1250 mm

Material: aluminum, natural anodised

- Accessories:**
- SZ1901S sealing rubber 40 4 mm
 - SZ1510S fixing block 40 Vario
 - SZ1903S sealing rubber 30 4 mm
 - SZ1540S fixing block 30 Vario



SZ1660G



SZ1662G

Aluminum Checker Plate

Part No	Description	Weight
SZ1664G	Aluminum Checker Plate 2.5 x 4.0 mm	8.2 kg / m ²

Application: Sheet material for protective walls and separator applications.

maximum size: 2500 mm x 1250 mm

Material: aluminum, blank (not degreased)



SZ1664G

Perforated Plate, Al

Part No	Description	Weight
SZ1666G	Perforated Plate, Al, 3 mm	5.5 kg / m ²

Application: Available from stock with 10 mm perforation in staggered rows. Distance to next hole / to next row: 15 mm

maximum size: 2500 mm x 1250 mm

Material: aluminum, blank (not degreased)

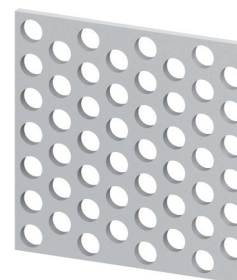

SZ1666G

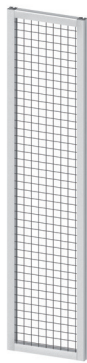

Protection Panel 500

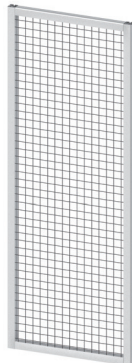

Protection Panel 750

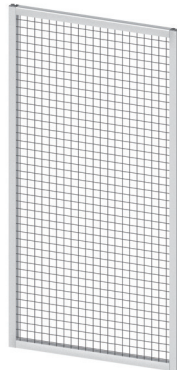

Protection Panel 1000

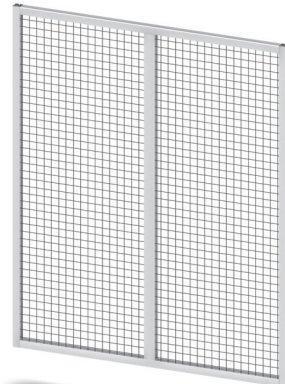

Protection Panel 1500



Support Legs 40 x 40 sl Support Legs 40 x 80 sl

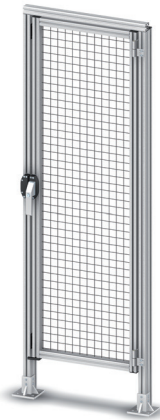

Door Kit 750

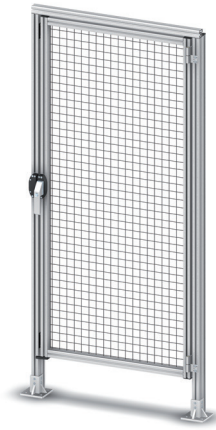

Door Kit 1000



Double Door Kit

- pre-assembled panels in standard sizes: 500, 750, 1000, 1500
- pre-assembled support legs
- compatible to the standard catalogue
- panel thickness: 7.8 mm

- doors and double doors with latching system
- slide doors with and without superstructure
- attachment of the frame elements to the support legs occurs via an adjustable holder and an adjustable angle

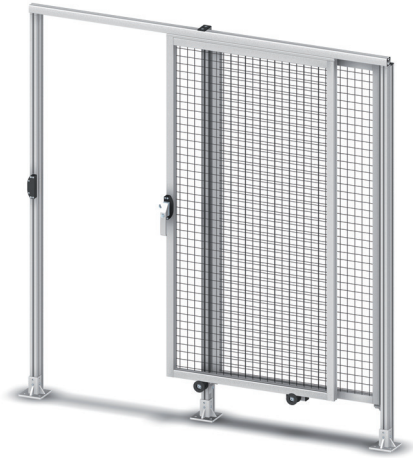

Sliding Door Kit, with superstructure

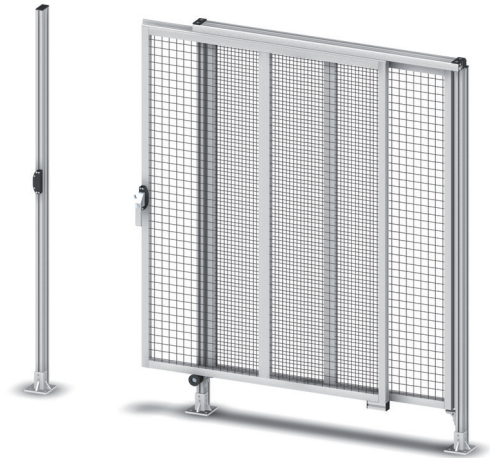

Sliding Door Kit, without superstructure



40



40 90°

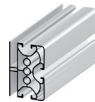

40 180°

Mesh Guarding Profiles 40



40 x 40, left

40 x 40, right

40 x 80, left

40 x 80, right

Door Latches



Stabilising Rollers

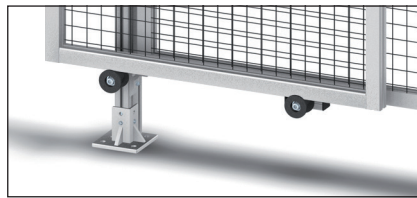

Protection Wall Lock



Metal Foot



Hinge 40 Al, natural

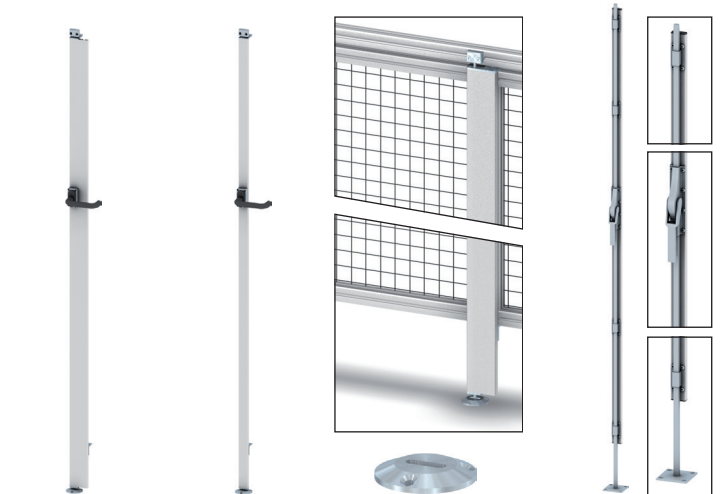

for double door

for single door

Catch Plate

Set Of Chute Bolts for doors

Protection Wall Latches



Angle 40 x 60



Angle 60 x 70



Bolt G-Type



Holder, adjustable

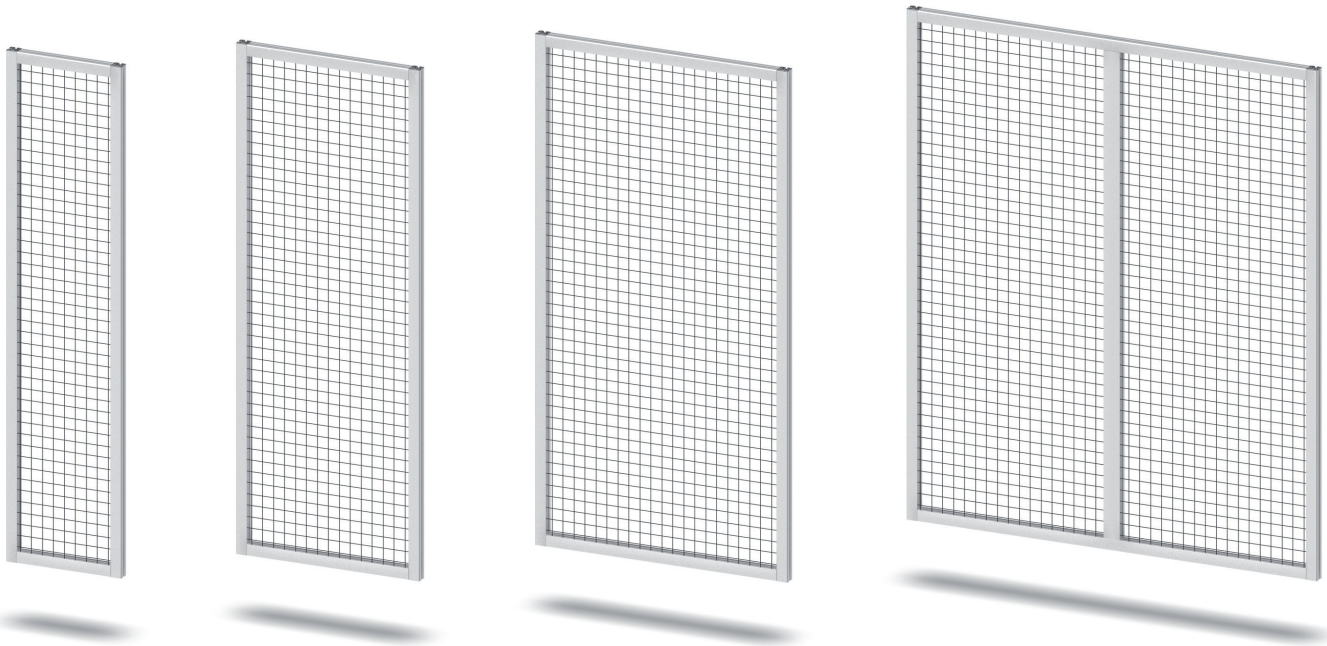

Protection Panel 500

Protection Panel 750

Protection Panel 1000

Protection Panel 1500

All panels are frontally tapped M 8.

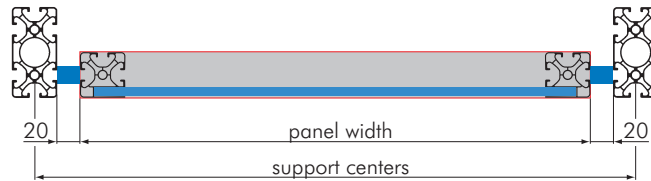

Protection Panels			
Part No	Description	Panel Width	Panel Height
SZ8032N	Protection Panel 500	420 mm	1800 mm
SZ8033N	Protection Panel 750	670 mm	1800 mm
SZ8034N	Protection Panel 1000	920 mm	1800 mm
SZ8035N	Protection Panel 1500	1420 mm	1800 mm

- Supply:**
- complete protection panel consisting of:
 - 4x mesh profile 40 x 40
 - vertical mesh profiles are frontally tapped M 8
 - 4x SV1301V central fastener 40 GC
 - 1x mesh 4 x 40 steel
 - 2x SZ8005N bolt type G

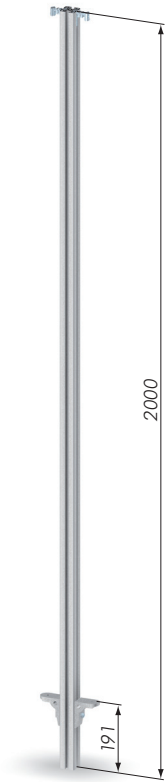

40 x 40 sl, with adjustable holder

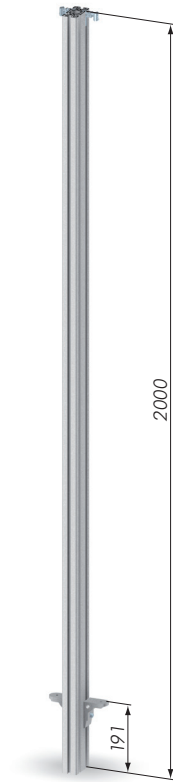

40 x 80 sl, with adjustable holder

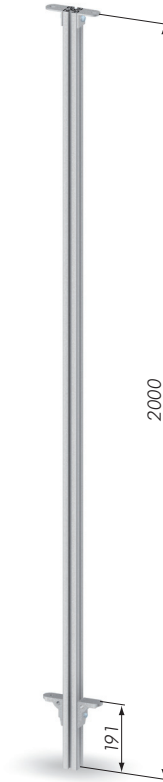

40 x 40 sl, with angle 40 x 60

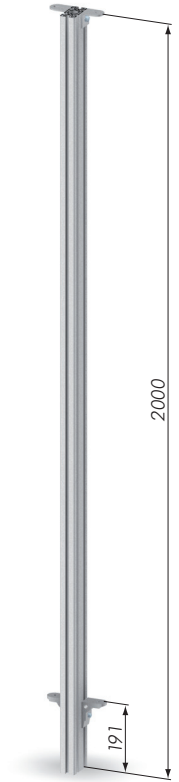

40 x 80 sl, with angle 40 x 60

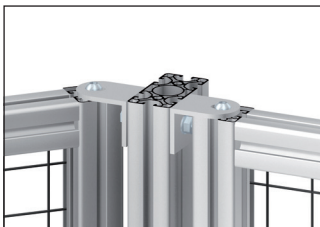

Protection Panel Supports		
Part No	Description	Total Height
SZ8038N	Prot. Panel Support 40 x 40 sl, with adj. holder	2000 mm
SZ8039N	Prot. Panel Support 40 x 80 sl, with adj. holder	2000 mm
SZ8036N	Prot. Panel Support 40 x 40 sl, with angle 40 x 60	2000 mm
SZ8037N	Prot. Panel Support 40 x 80 sl, with angle 40 x 60	2000 mm



Supply:

- 1x profile 40 x 40 sl alternatively 40 x 80 sl
- 2x SZ8001N angle 60 x 70, complete with attachment screws
- 2x SZ8010V holder, adjustable via milled nuts, alternatively:
- 2x SZ8000N angle 40 x 60 with 1 attachment screw per angle

The attachment screw and the adjustable holder are supplied with a spring-loaded ball to give positive positioning in the t-slot.

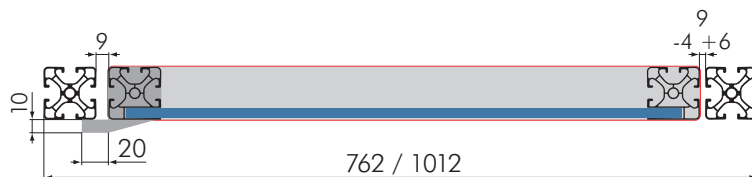
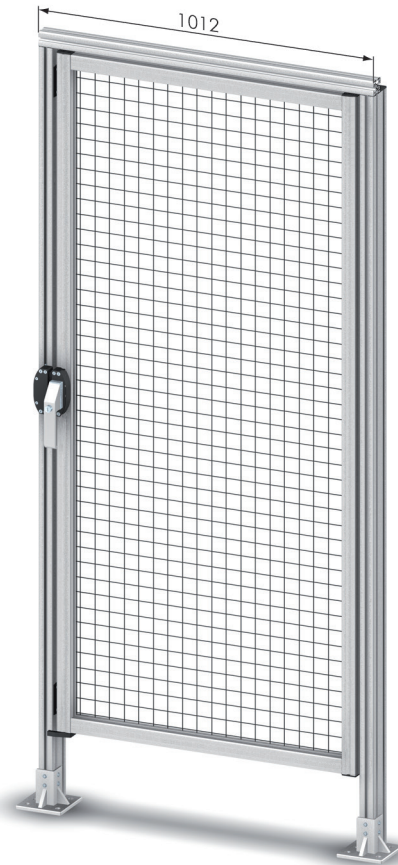
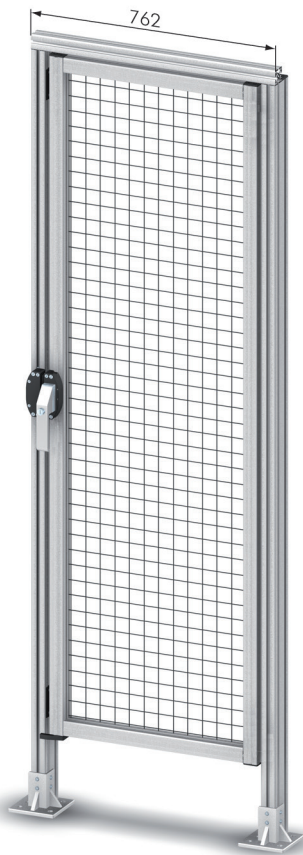

Door Kits			
Part No	Description	Width	Total Height
SZ8028N	Door Kit 750	670 mm	2000 mm
SZ8030N	Door Kit 1000	920 mm	2000 mm



Supply:

- 1x profile 40 x 40 sl, L = 762 mm, for SZ8028N with two bore holes
- 1x profile 40 x 40 sl, L = 1012 mm, for SZ8030N with two bore holes
- 2x SZ8014N hinge, Al, with fasteners

- Not Included:**
- protection panels
 - protection wall support profiles
 - mounting feet
 - protection wall or handle
 - safety switch
 - lower door stop
 - upper door stop, round, alternatively top door-stop plate

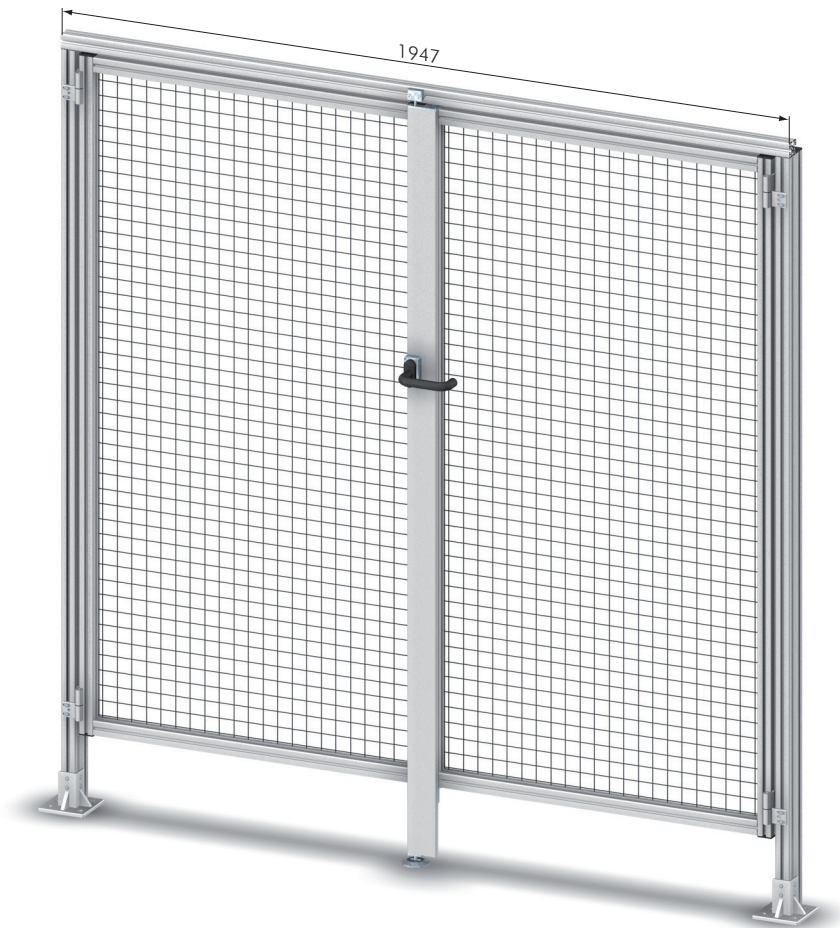

Double Door Kit		
Part No	Description	Total height
SZ8026N	Double Door Kit	2000 mm



Supply:

- 1x protection wall latch for double doors consisting of:
 - profile 16 x 80
 - double door locking
 - base plate
 - upper locking receiver
- 4x SZ8014N hinge, Al, with fasteners
- 1x profile 40 x 40 sl, L = 1947 mm, with two bore holes

Not Included:

- protection panels
- protection wall support profiles
- mounting feet
- safety interlock

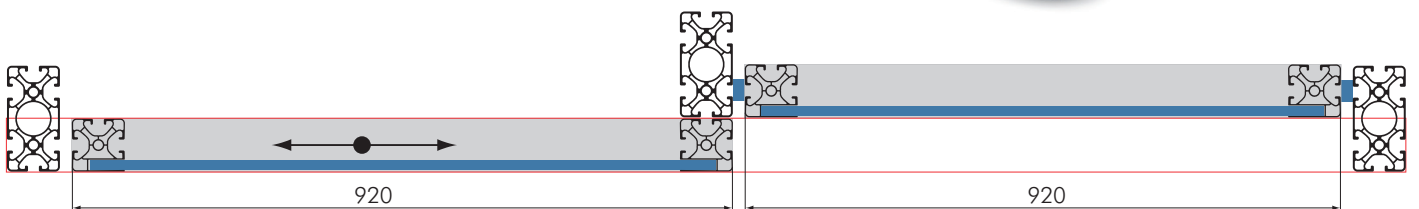
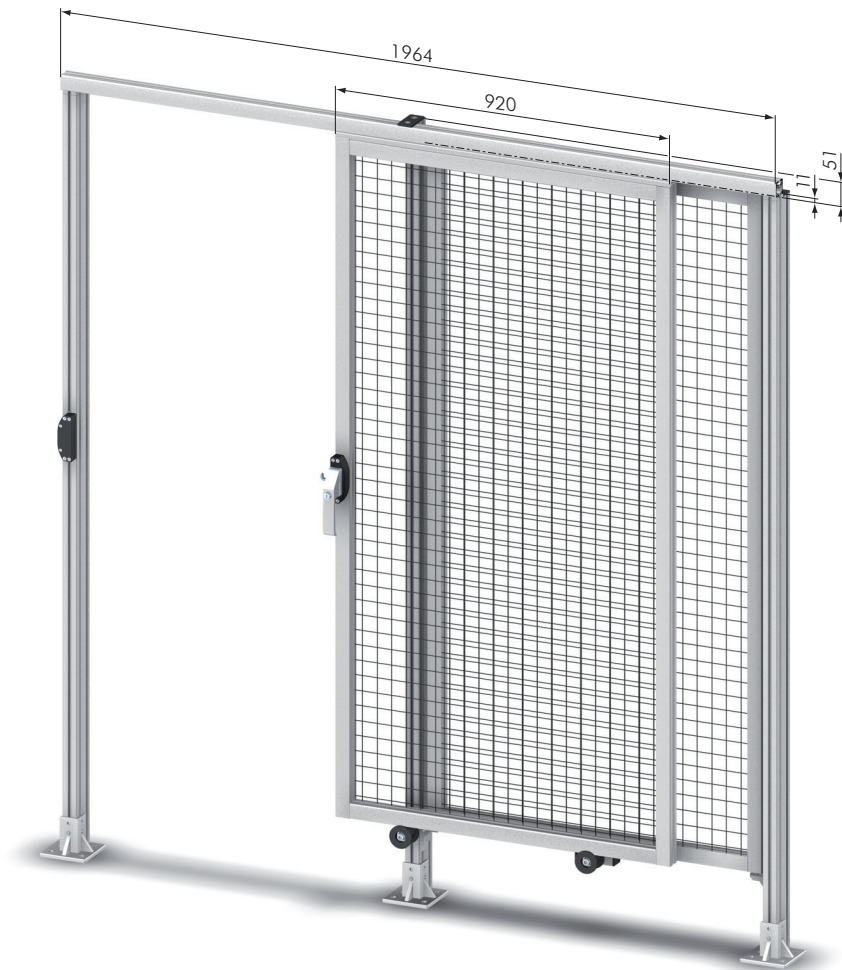

Sliding Door Kits		
Part No	Description	Total height
SZ8023N	Sliding Door Kit, with superstructure	2000 mm



Supply:

- 1x linear actuator C 40 x 57, L = 1964 mm, with carriage, L = 920 mm
- 2x SV1301V central fastener 40 GC to connect the carriage to the panel 1000
- 1x distance profile 40 x 40 sl, L = 51 mm, with screws and holding plate
- 2x distance profile 40 x 40 sl, L = 11 mm, with screws
- 2x SZ1910S rubber cover 32 x 4, L = 1815 mm,
- 1x SZ8044S stabilizing roller for supporting sliding doors to vertical profiles
- 1x SZ8045S stabilizing roller for supporting sliding doors at the lower horizontal profile

- protection wall support profiles
- mounting feet
- protection wall lock
- protection wall handle
- safety interlock

Not Included: • protection panels

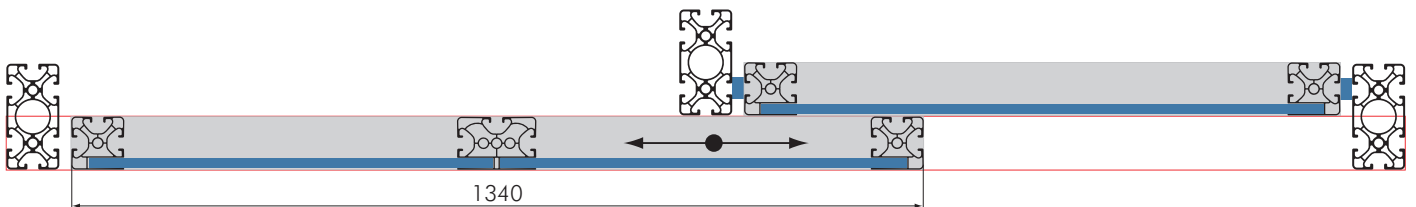
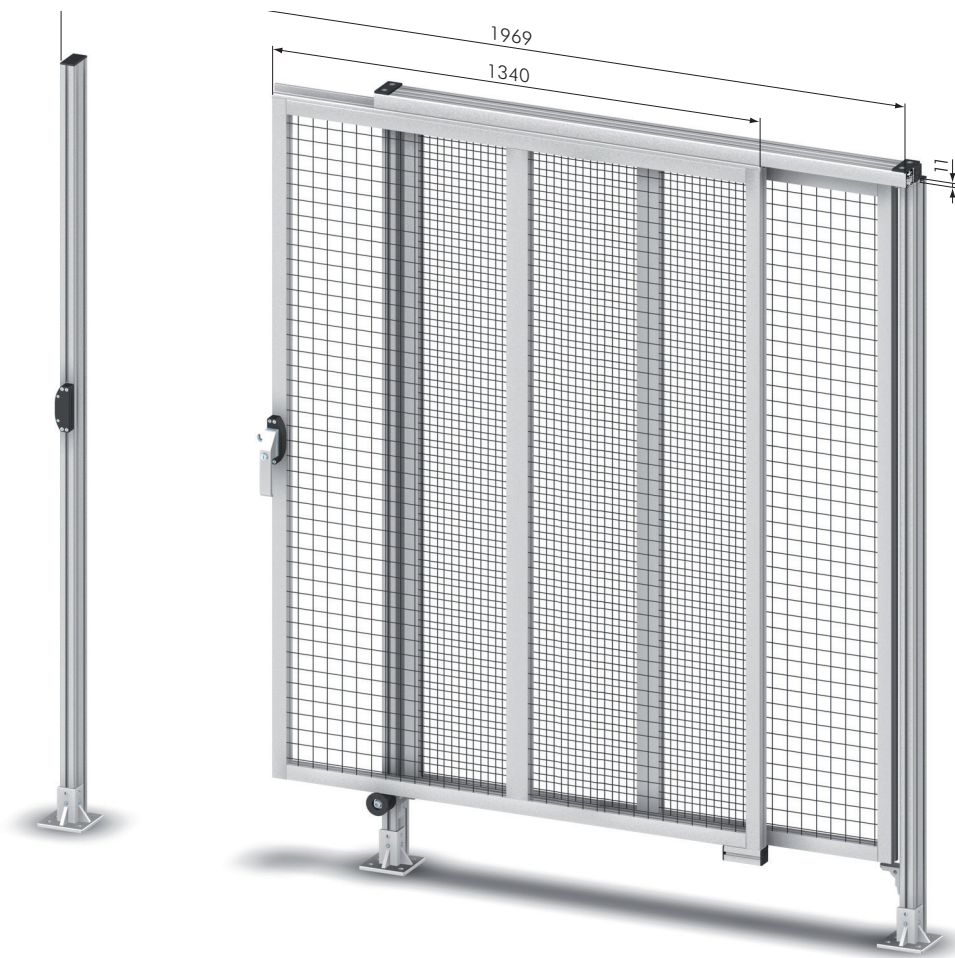

Sliding Door Kits

Part No	Description	Total Height
SZ8025N	Sliding Door Kit, without superstructure	2000 mm

40

Supply:

- 1x linear actuator C 40 x 57, L = 1969 mm, with carriage, L = 1340 mm
- 2x SV1301V central fastener 40 GC to connect the carriage to the panel 1000
- 1x distance profile 40 x 40 sl, L = 51 mm, with screws and holding plate
- 2x distance profile 40 x 40 sl, L = 11 mm, with screws
- 2x SZ1910S rubber cover 32 x 4 L = 1815 mm
- 1x SZ8044S stabilizing roller for supporting sliding doors to vertical profiles
- 1x SZ8045S stabilizing roller for supporting sliding doors at the lower horizontal profile

Not Included:

- protection panels
- protection wall support profiles
- mounting feet
- protection wall lock
- protection wall handle
- safety interlock

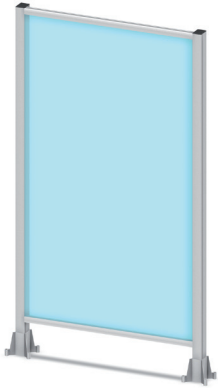

Frame Element 60 x 80

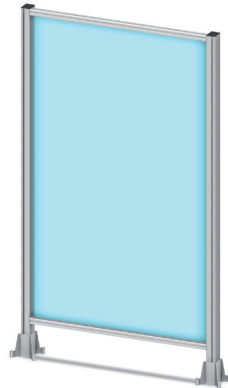

Frame Element 60 x 80 5N

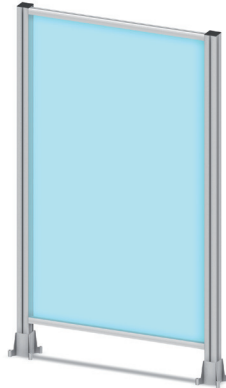

Frame Element 80 x 80

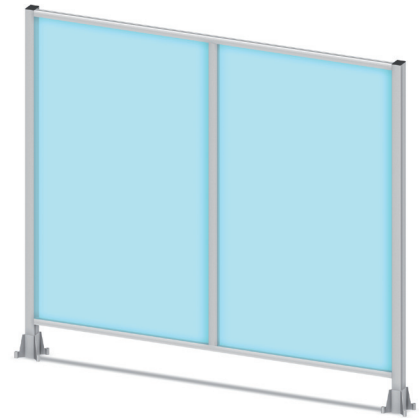

Double Frame Element 60 x 80

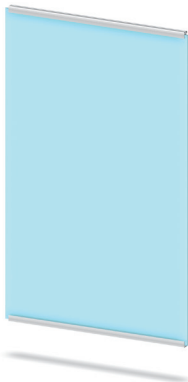

Internal Element 60 x 80 3N

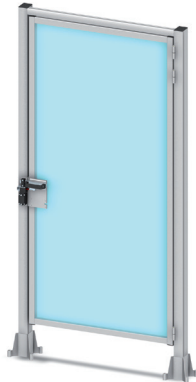

Door Element 60 x 80

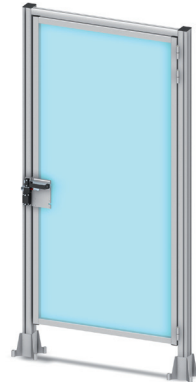

Door Element 60 x 80 5N

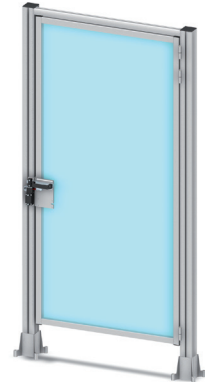

Door Element 80 x 80



40 / 4



40 / 4 8.6



40 / 4 semi



40 / 4 8.6 semi



Hinge 40 Al, natural



Locking Mechanisms

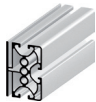

40 / 4 180°

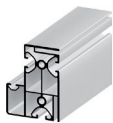

60 x 80



60 x 80



60 x 80 5N

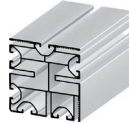

80 x 80



Stabilizing Rollers

- for 4 mm panels
- preassembled frames in standard sizes with differing number of t-slots (3/5/6)
- preassembled support legs
- compatible to the standard program
- lockable single doors and double doors
- smooth, clean surfaces
- various applications

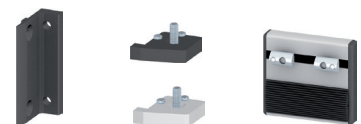

Door Stops



Double Door Element 60 x 80



Double Door Element 60 x 80 5N



Double Door Element 80 x 80

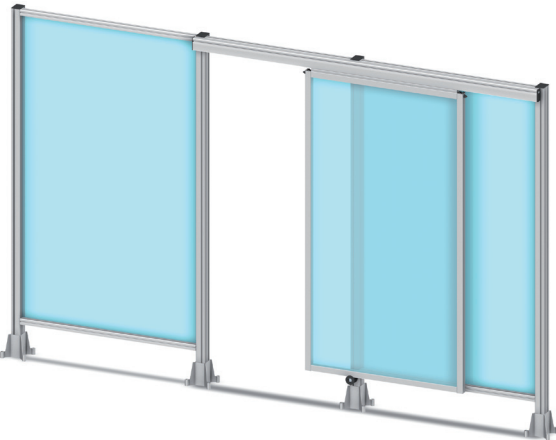

Sliding Door Element 60 x 80

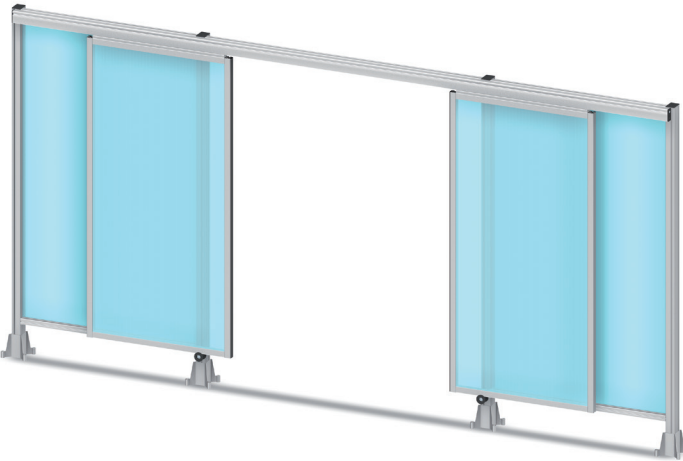

Double Sliding Door Element 60 x 80

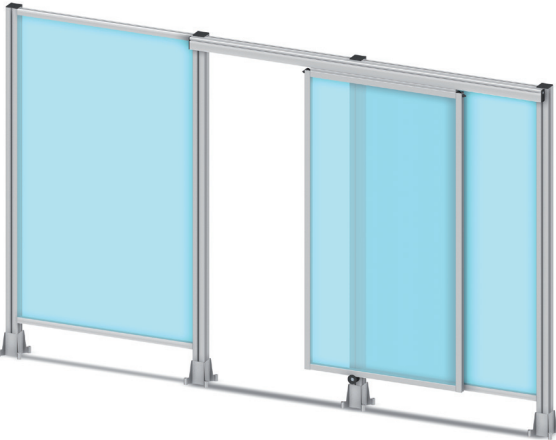

Sliding Door Element 80 x 80

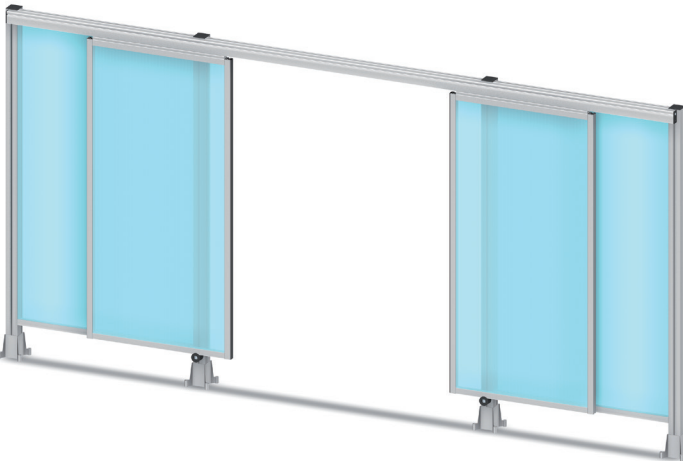

Double Sliding Door Element 80 x 80

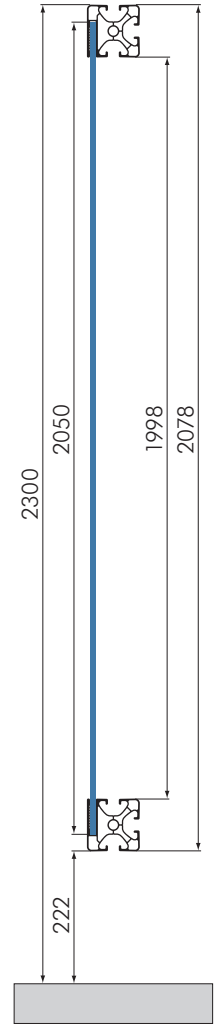
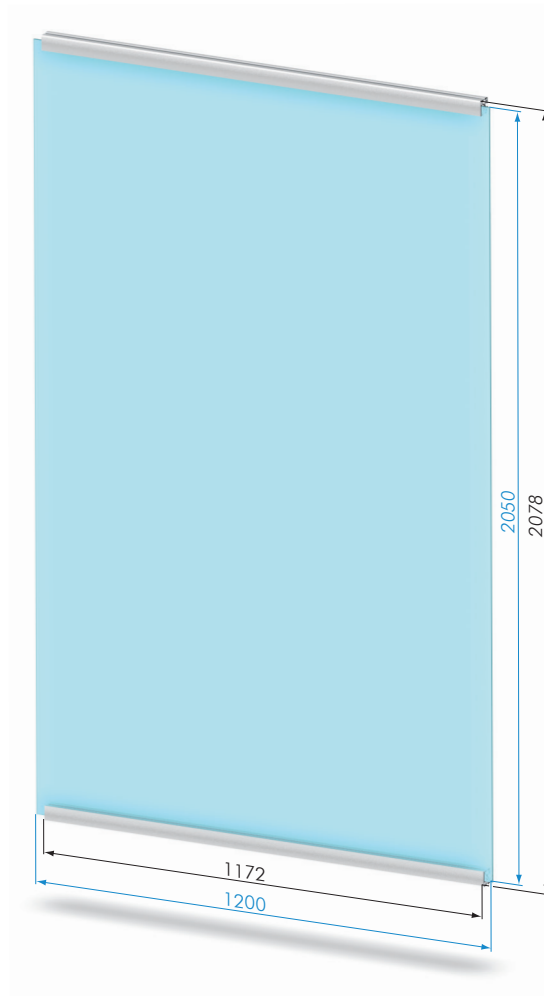

Internal Elements		
Part No	Description	Total height
SZ8130N	Internal Element	2300 mm



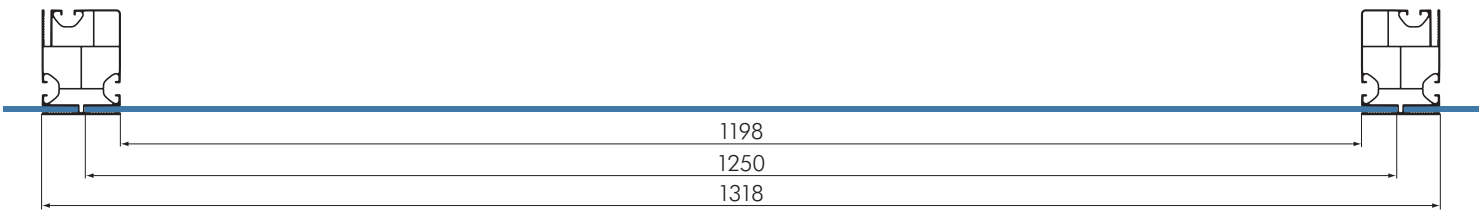
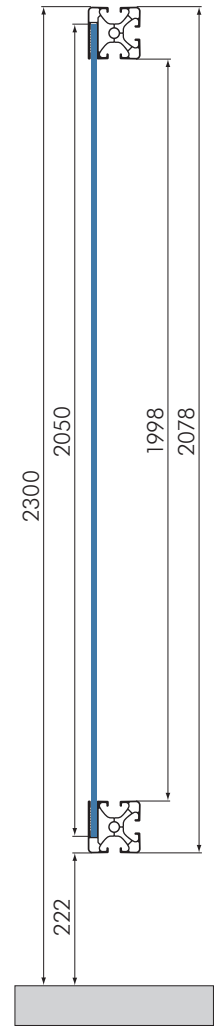
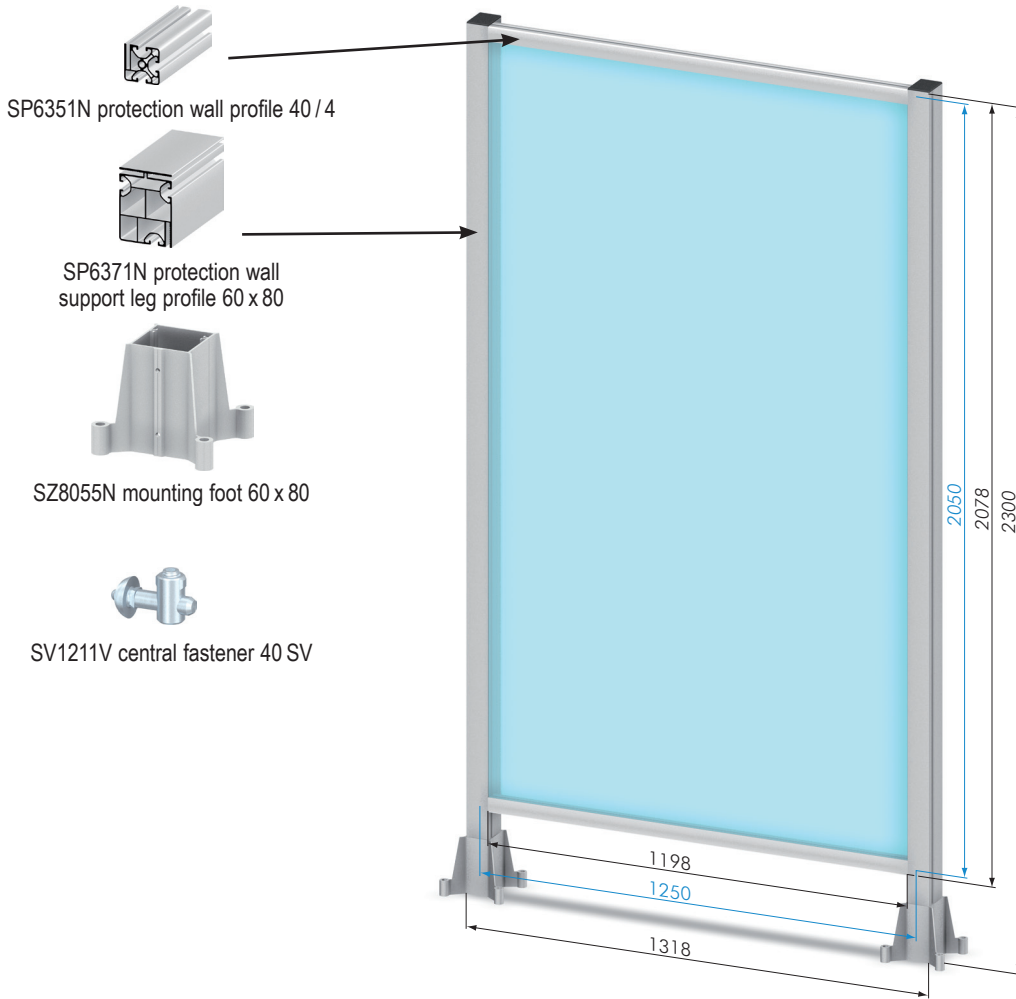

Frame Elements		
Part No	Description	Total height
SZ8100N	Frame Element 60 x 80	2300 mm

40

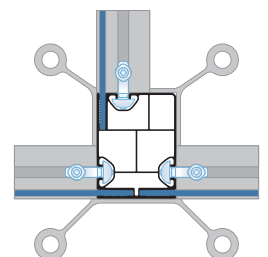

H Protection and Separating Wall Systems
22 Frame Elements

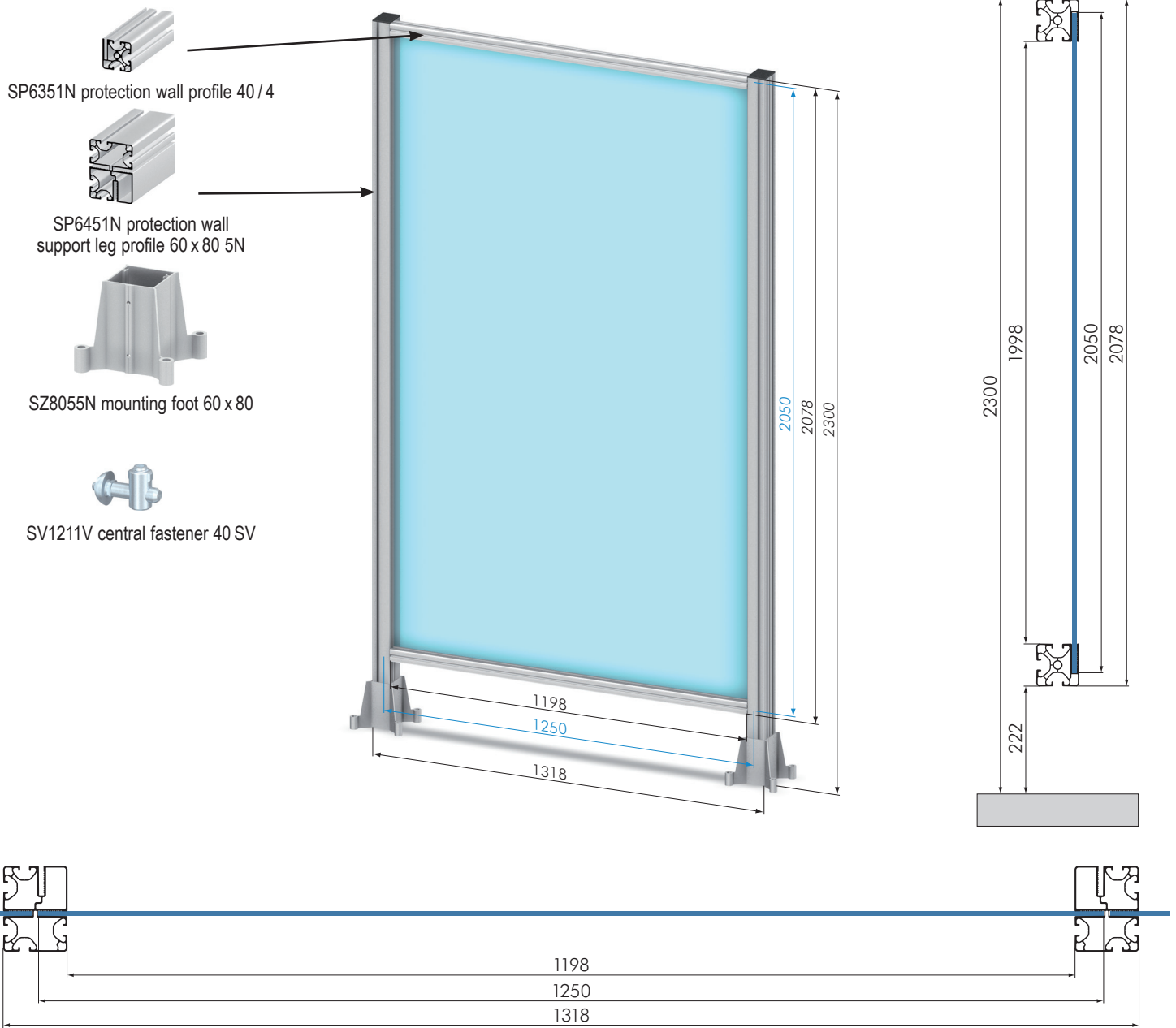

Frame Elements		
Part No	Description	Total height
SZ8102N	Frame Element 60 x 80 5N	2300 mm

40

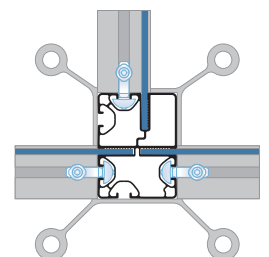

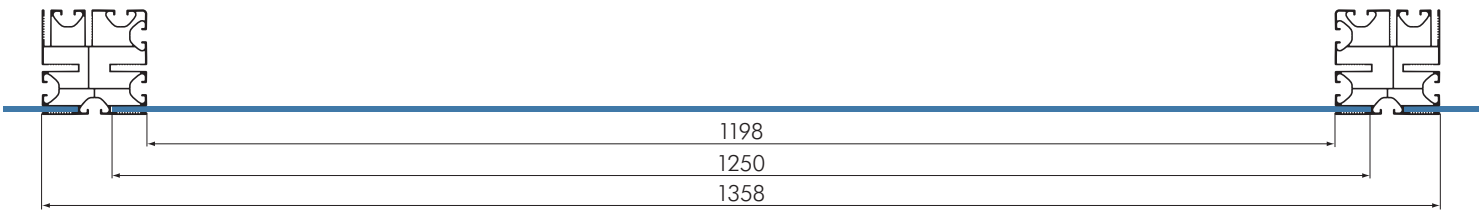
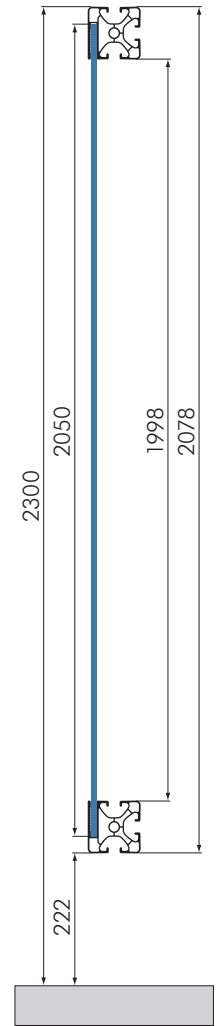
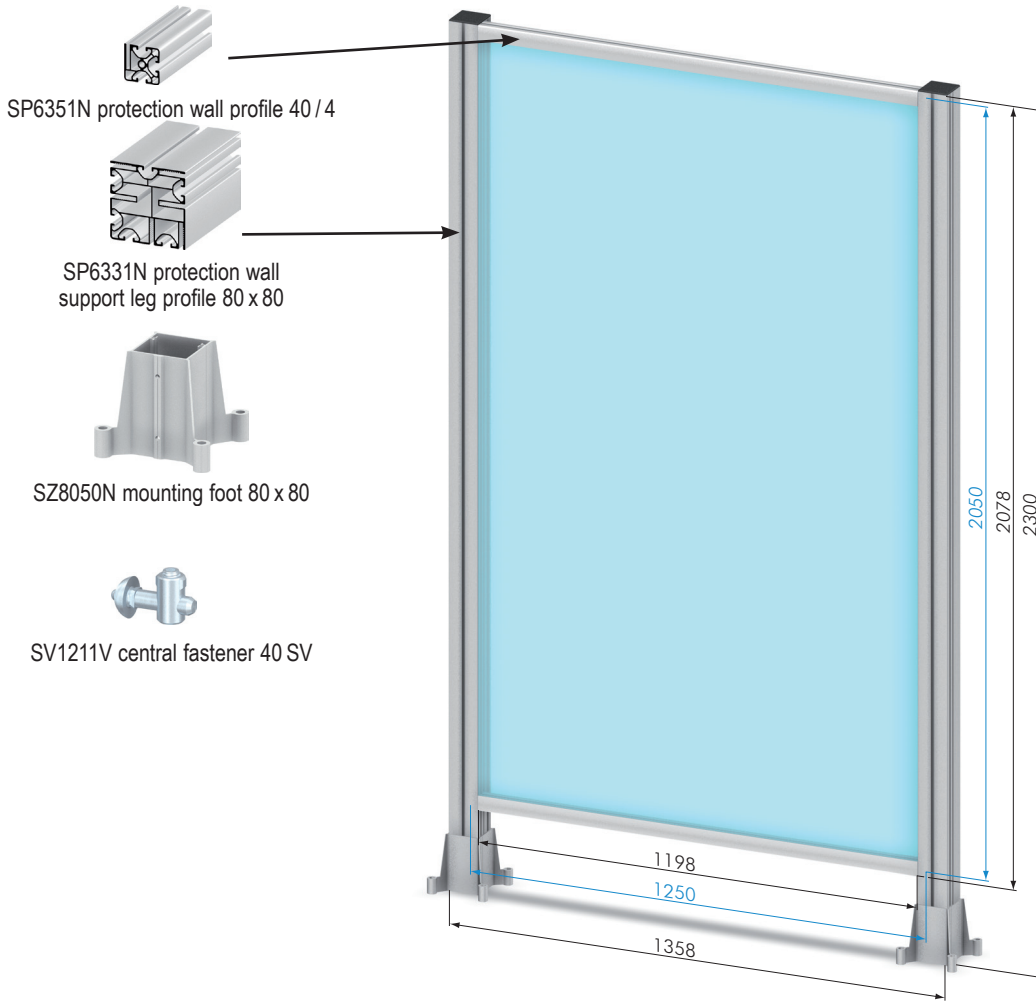

Frame Elements		
Part No	Description	Total height
SZ8101N	Frame Element 80 x 80	2300 mm

40

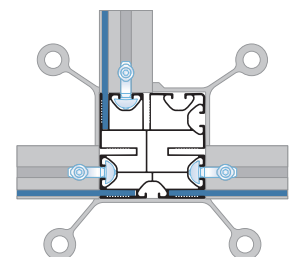

H Protection and Separating Wall Systems
24 Double Frame Elements

PALETTI

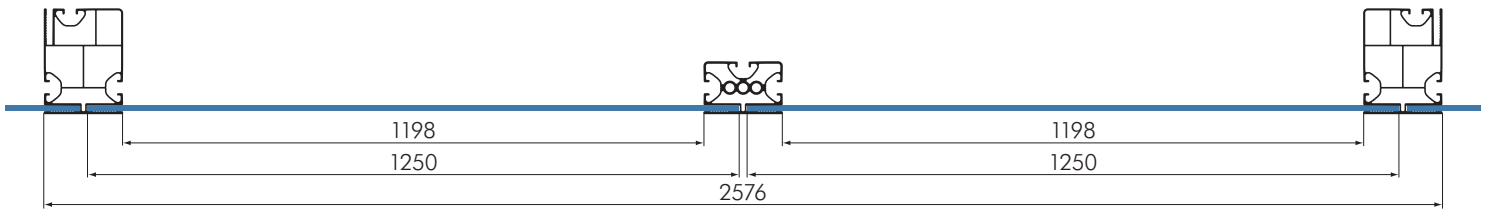
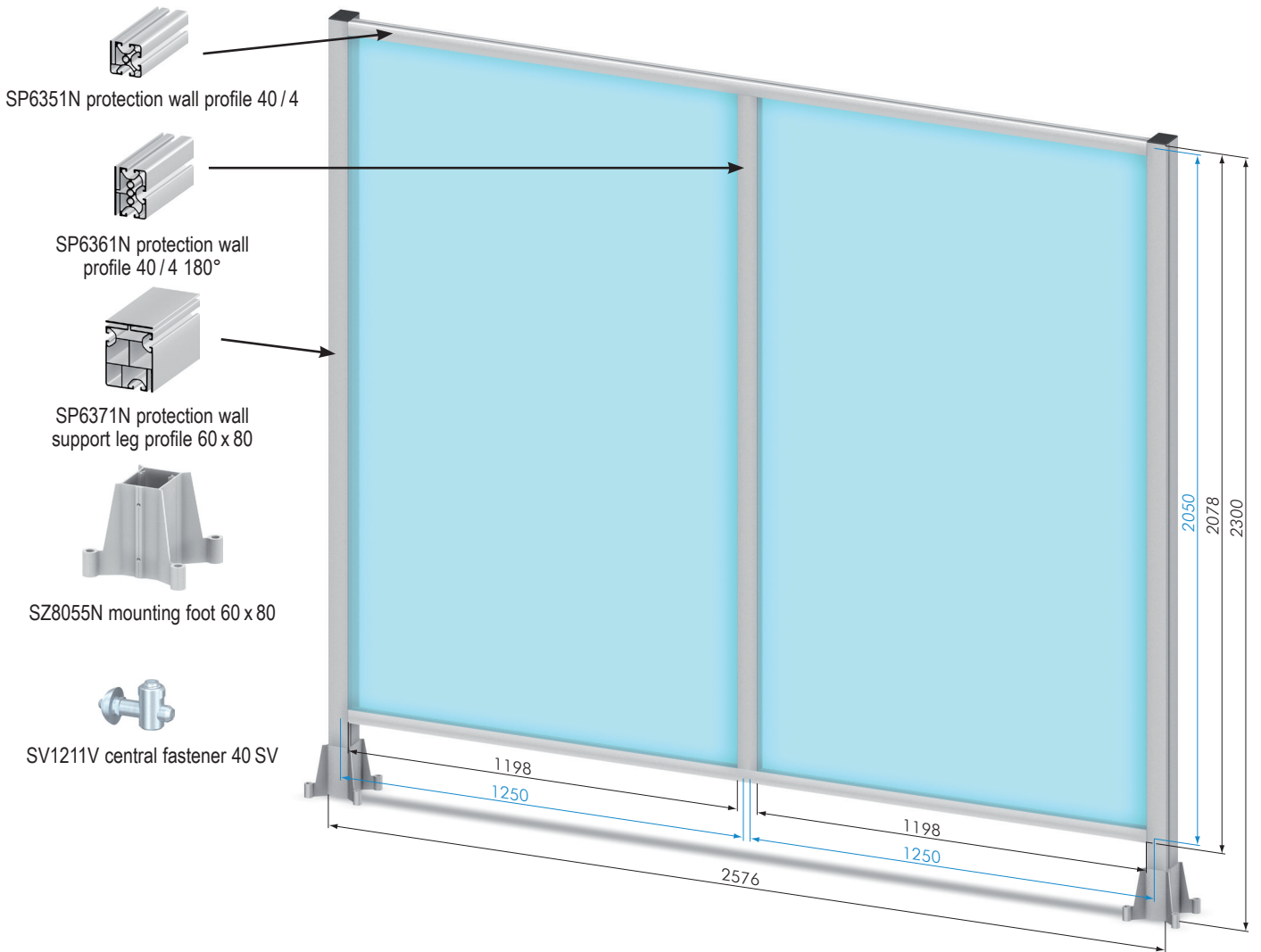

Double Frame Elements

Part No	Description	Total height
SZ8125N	Double Frame Element 60 x 80	2300 mm

40

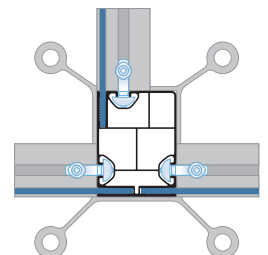

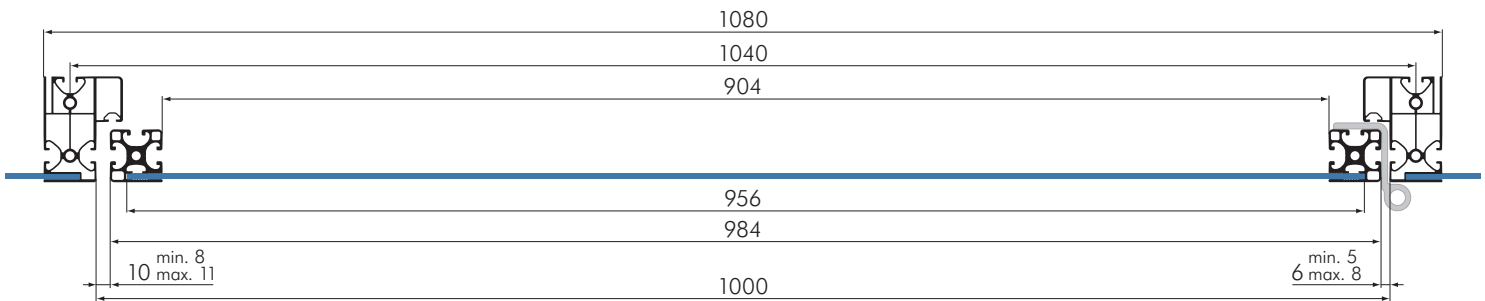
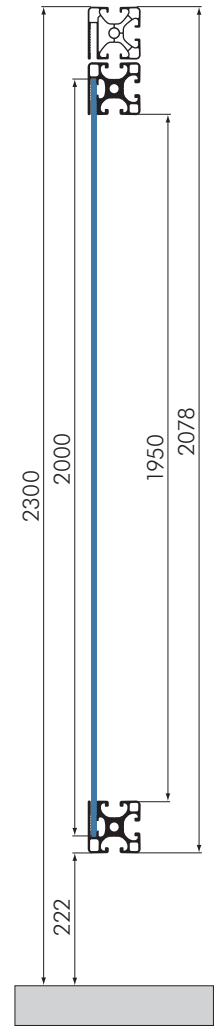
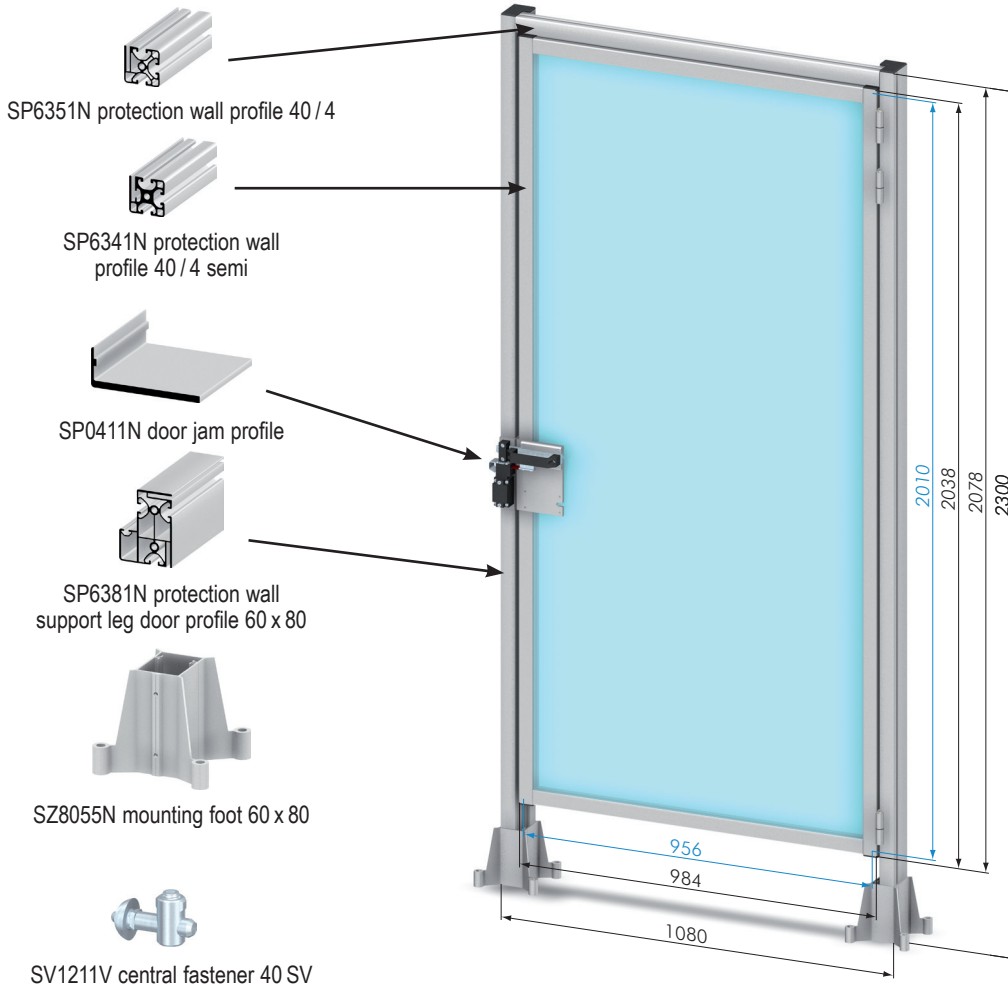

Door Elements		
Part No	Description	Total height
SZ8110N	Door Element 60 x 80	2300 mm

40

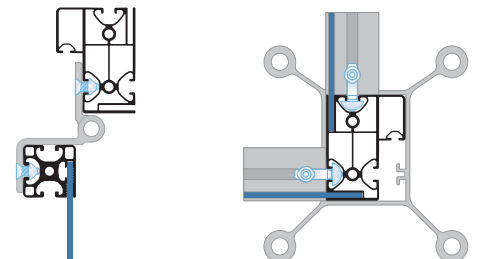

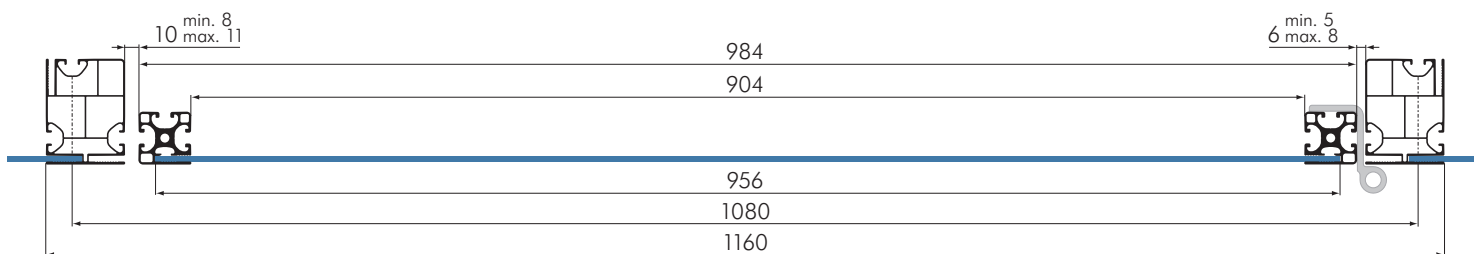
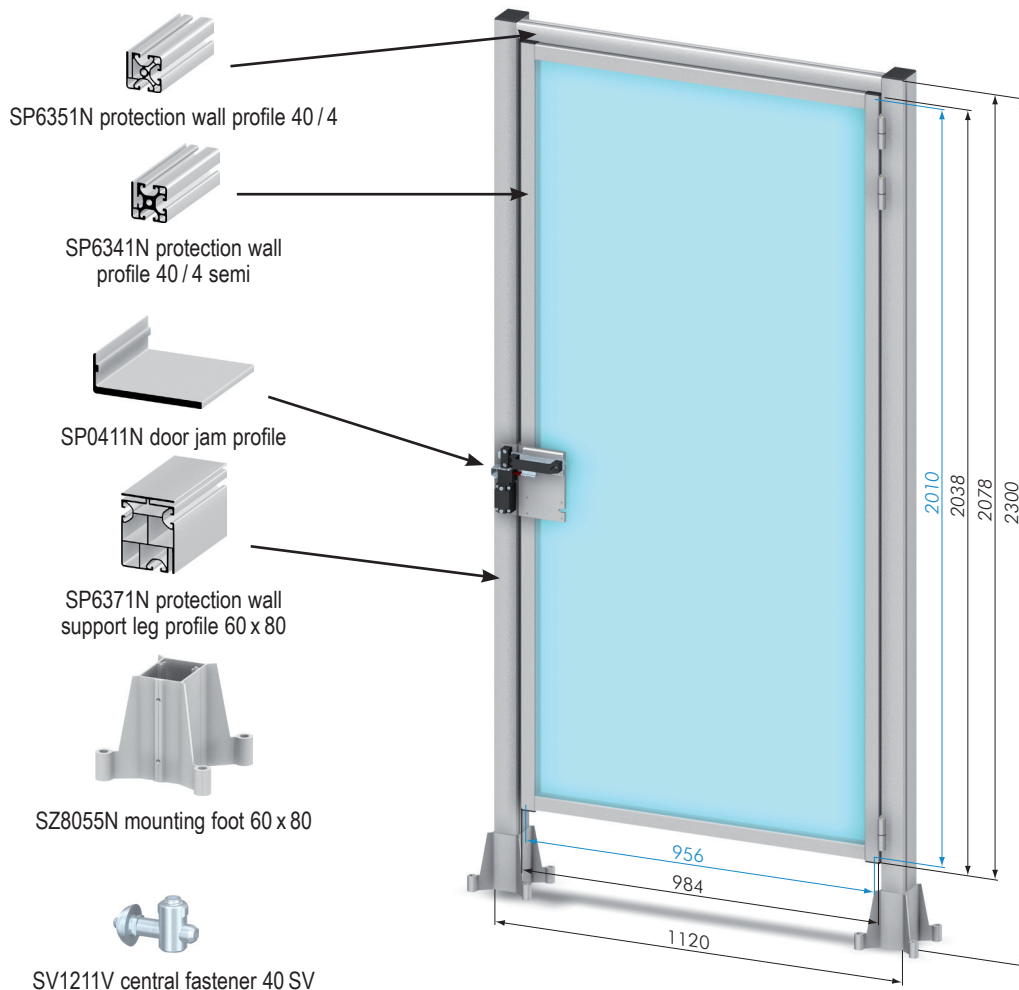

Door Elements		
Part N°	Description	Total height
SZ8112N	Door Element 60 x 80	2300 mm

40

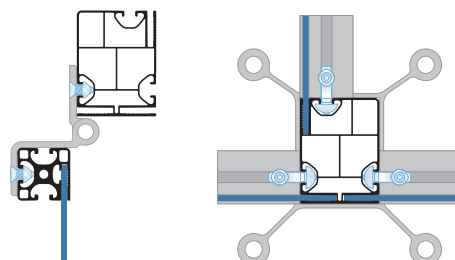

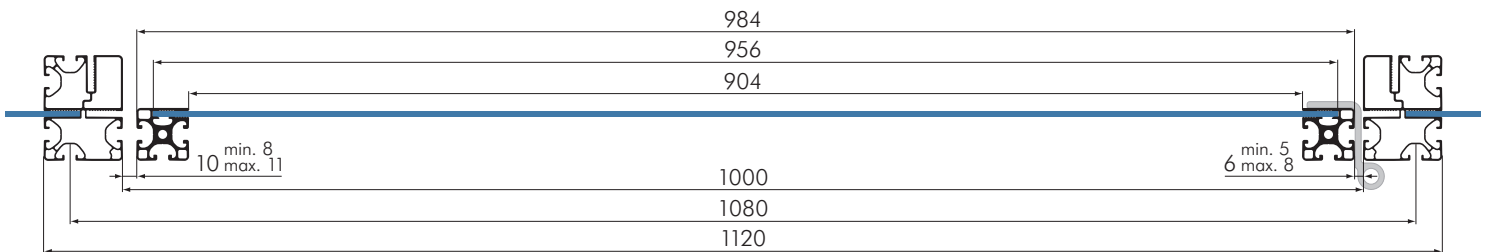
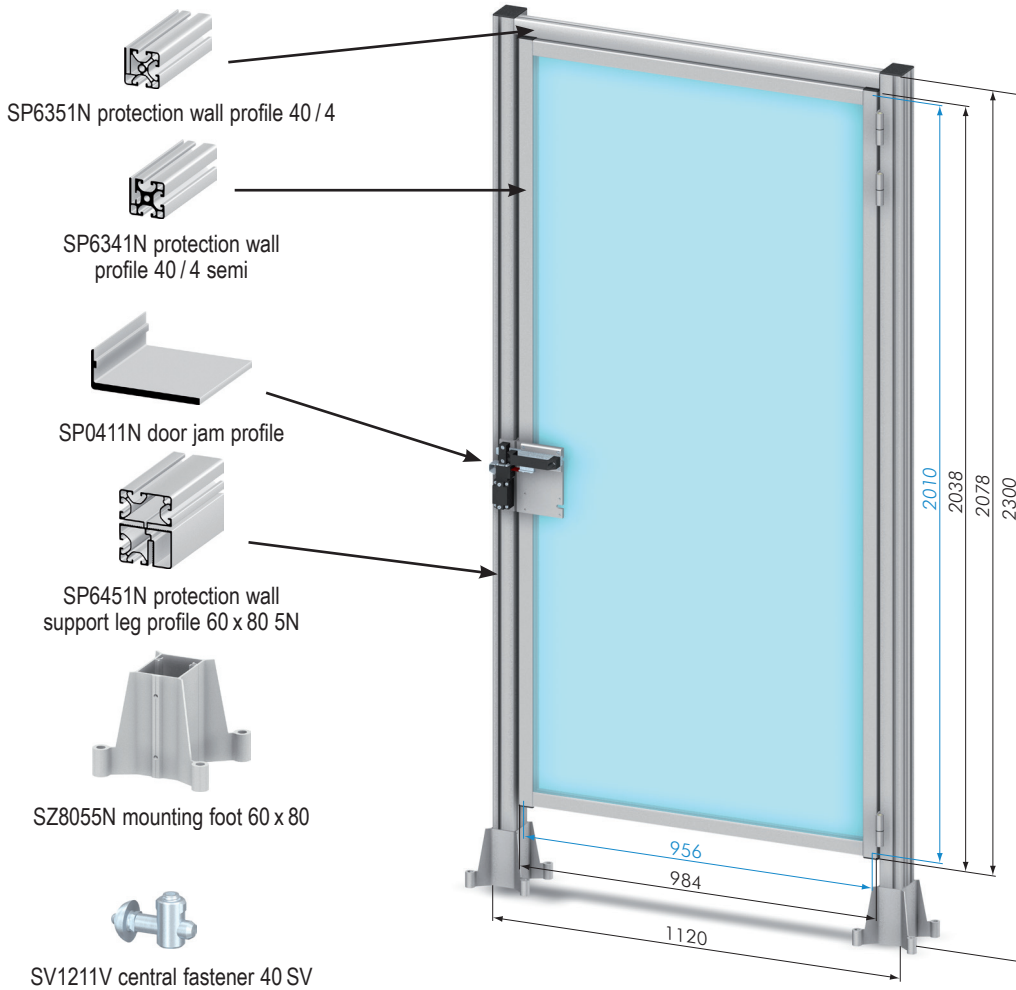

Door Elements		
Part No	Description	Total height
SZ8113N	Door Element 60x80 5N	2300 mm

40

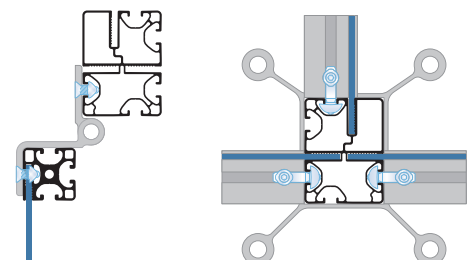

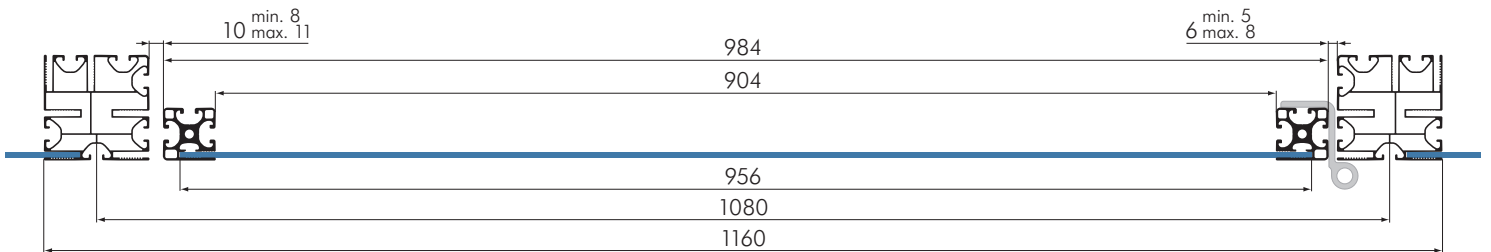
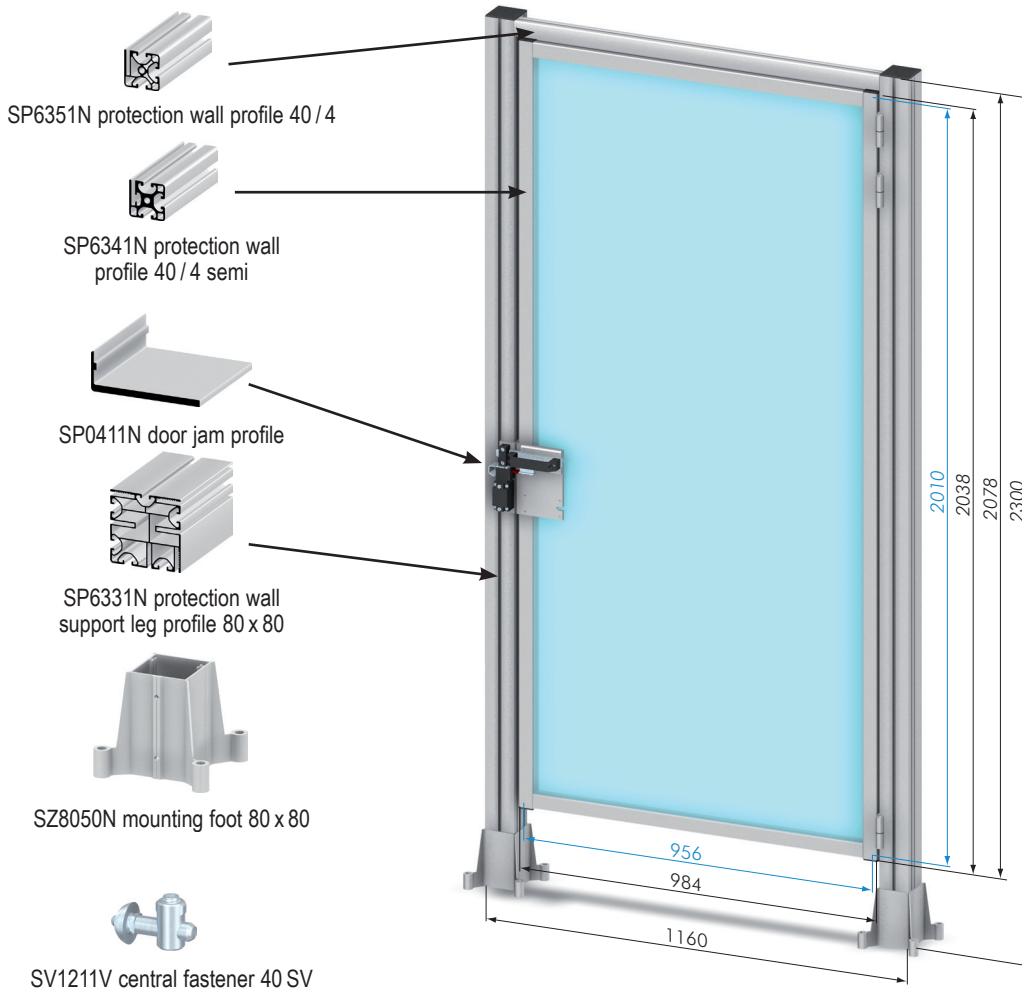

Door Elements		
Part No	Description	Total height
SZ8111N	Door Element 80 x 80	2300 mm

40

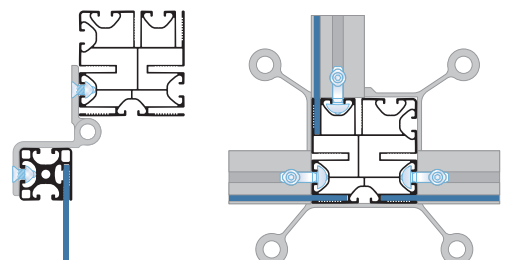

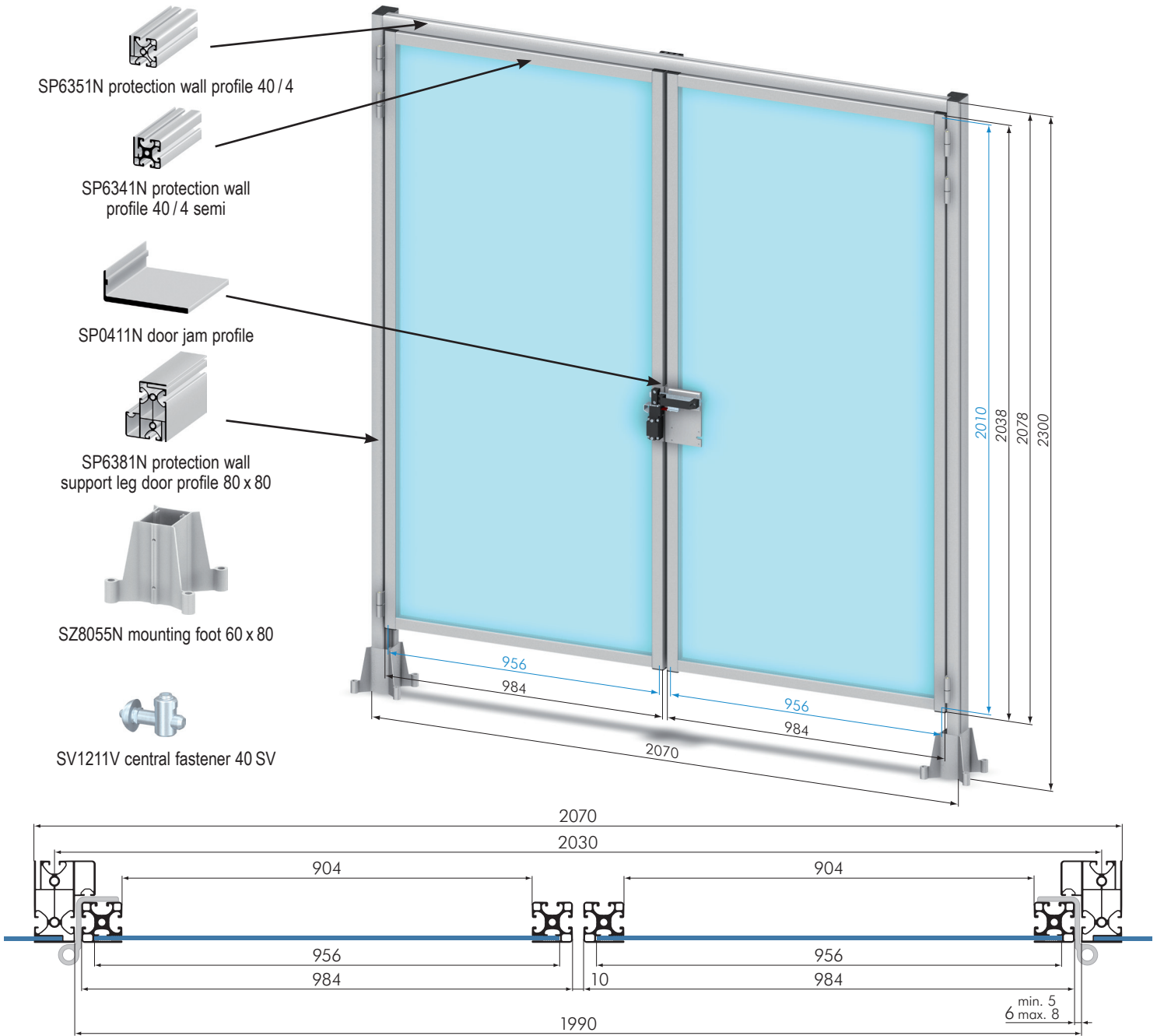

Double Door Elements

Part No	Description	Total height
SZ8120N	Double Door Element 60 x 80	2300 mm

40

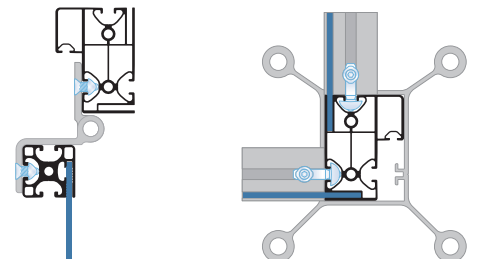

H Protection and Separating Wall Systems
30 Double Door Elements

PALETTI

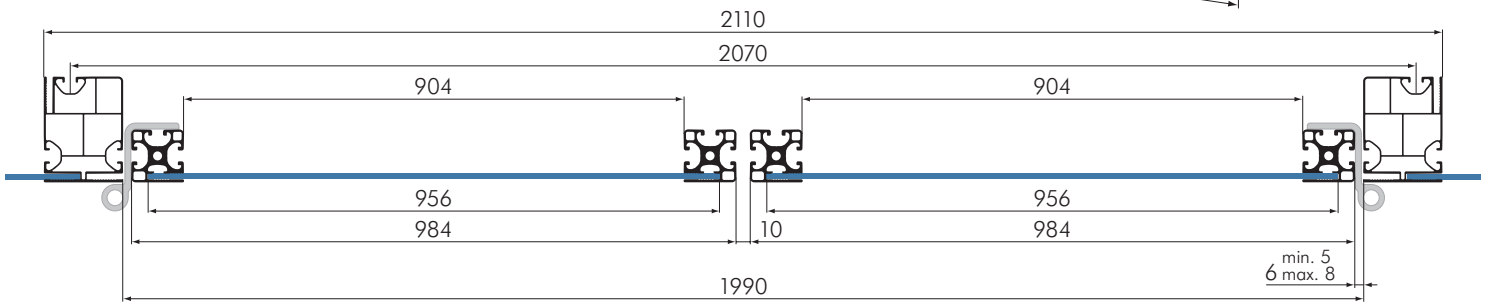
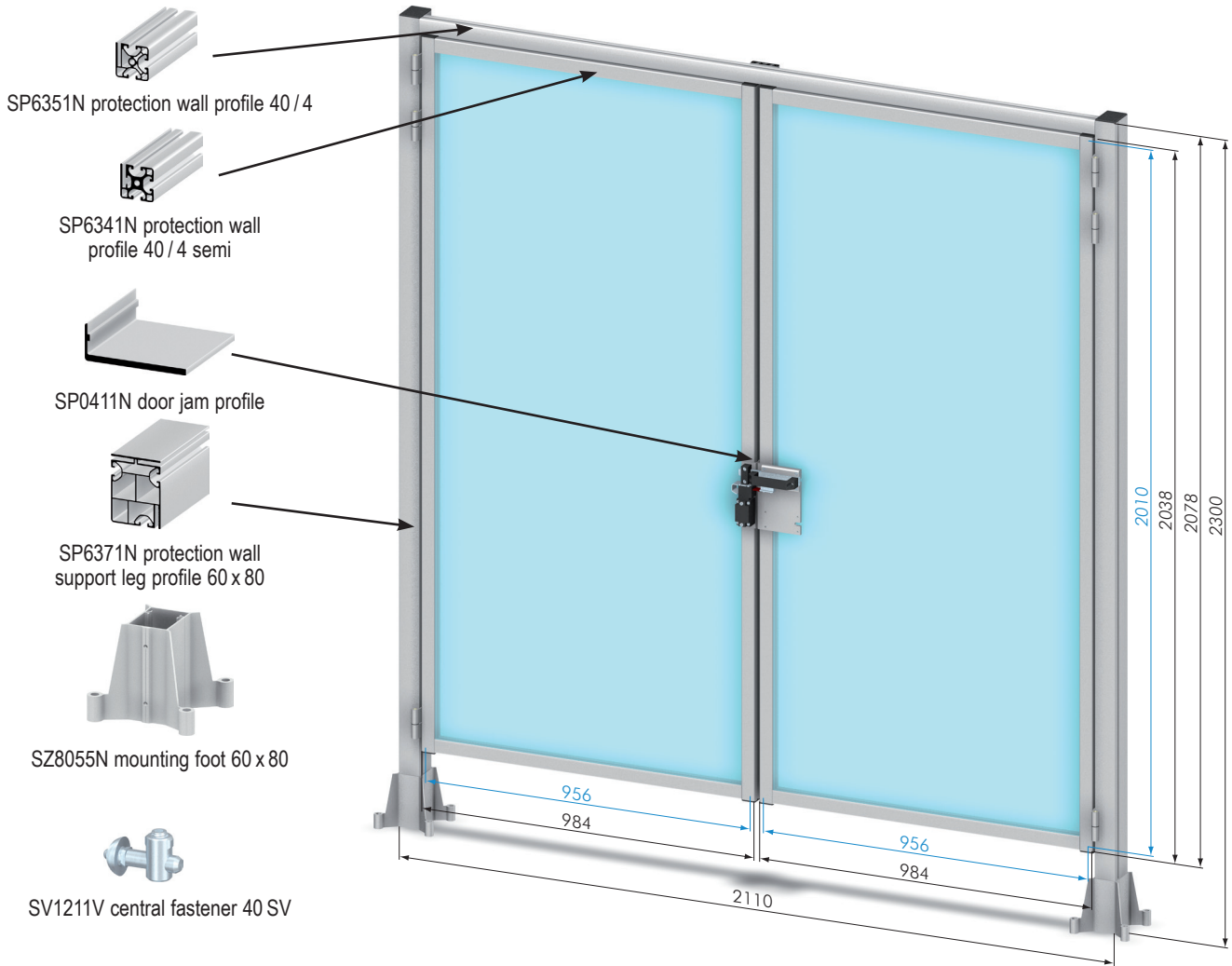

Double Door Elements		
Part N°	Description	Total height
SZ8122N	Double Door Element 60 x 80	2300 mm

40

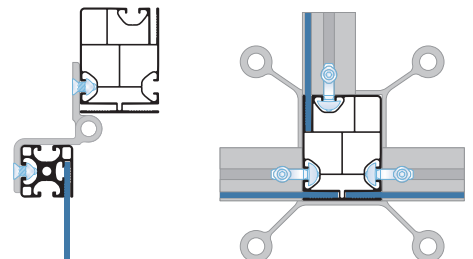

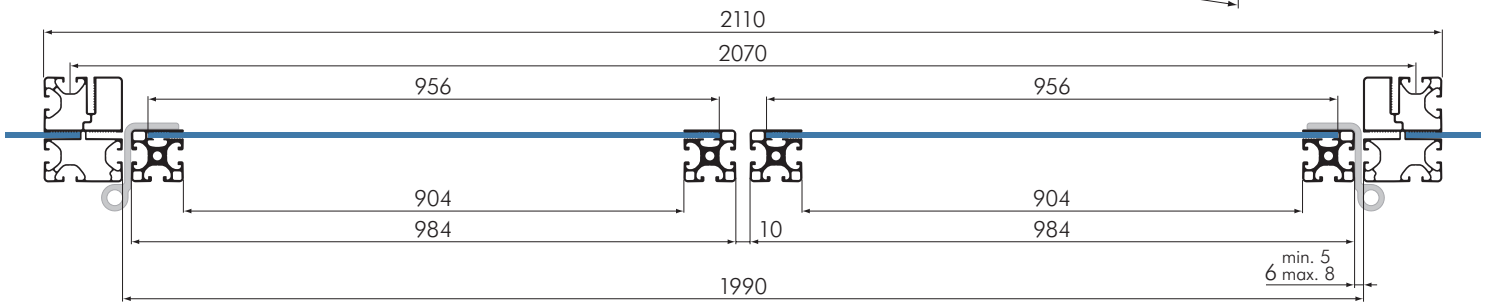
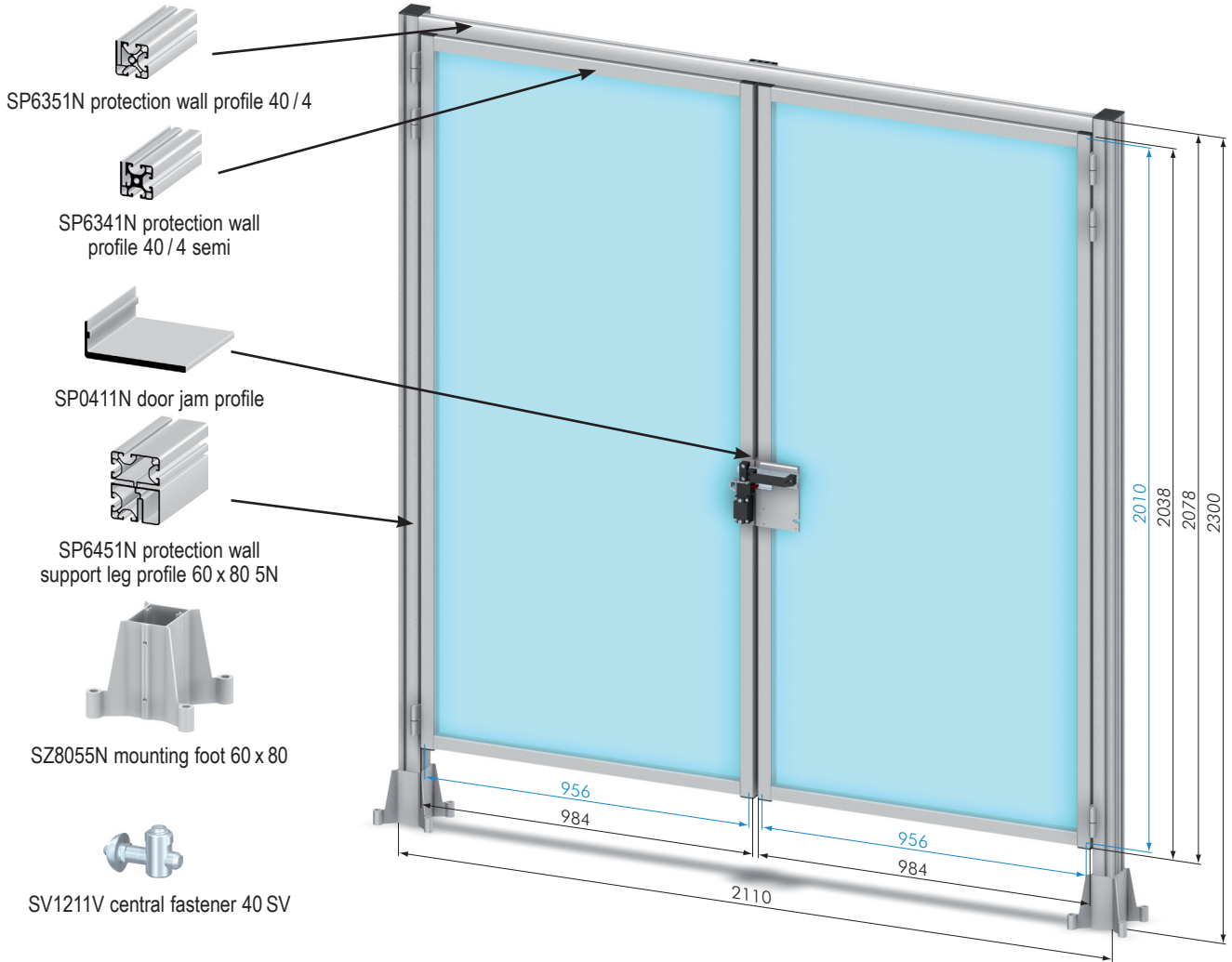

Double Door Elements		
Part No	Description	Total height
SZ8123N	Double Door Element 60 x 80 5N	2300 mm

40

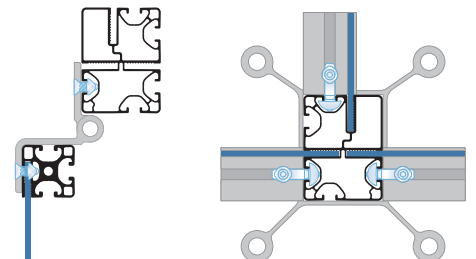

H Protection and Separating Wall Systems
32 Double Door Elements

PALETTI

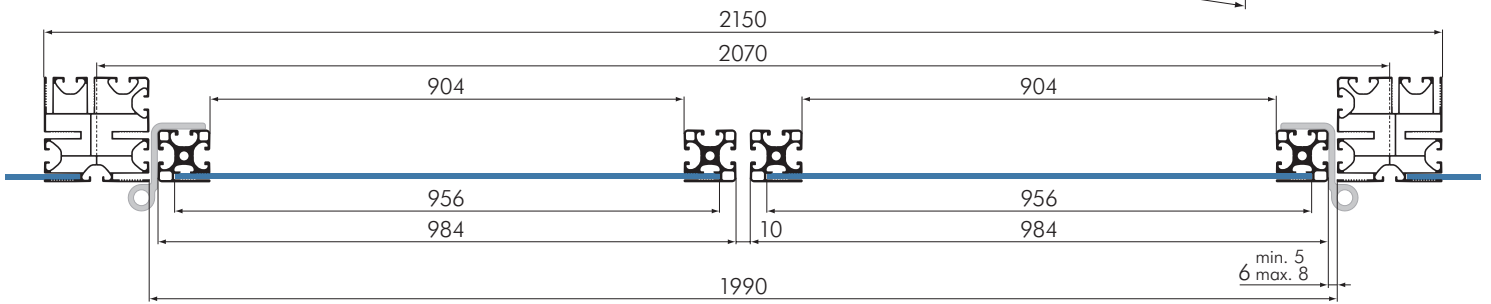
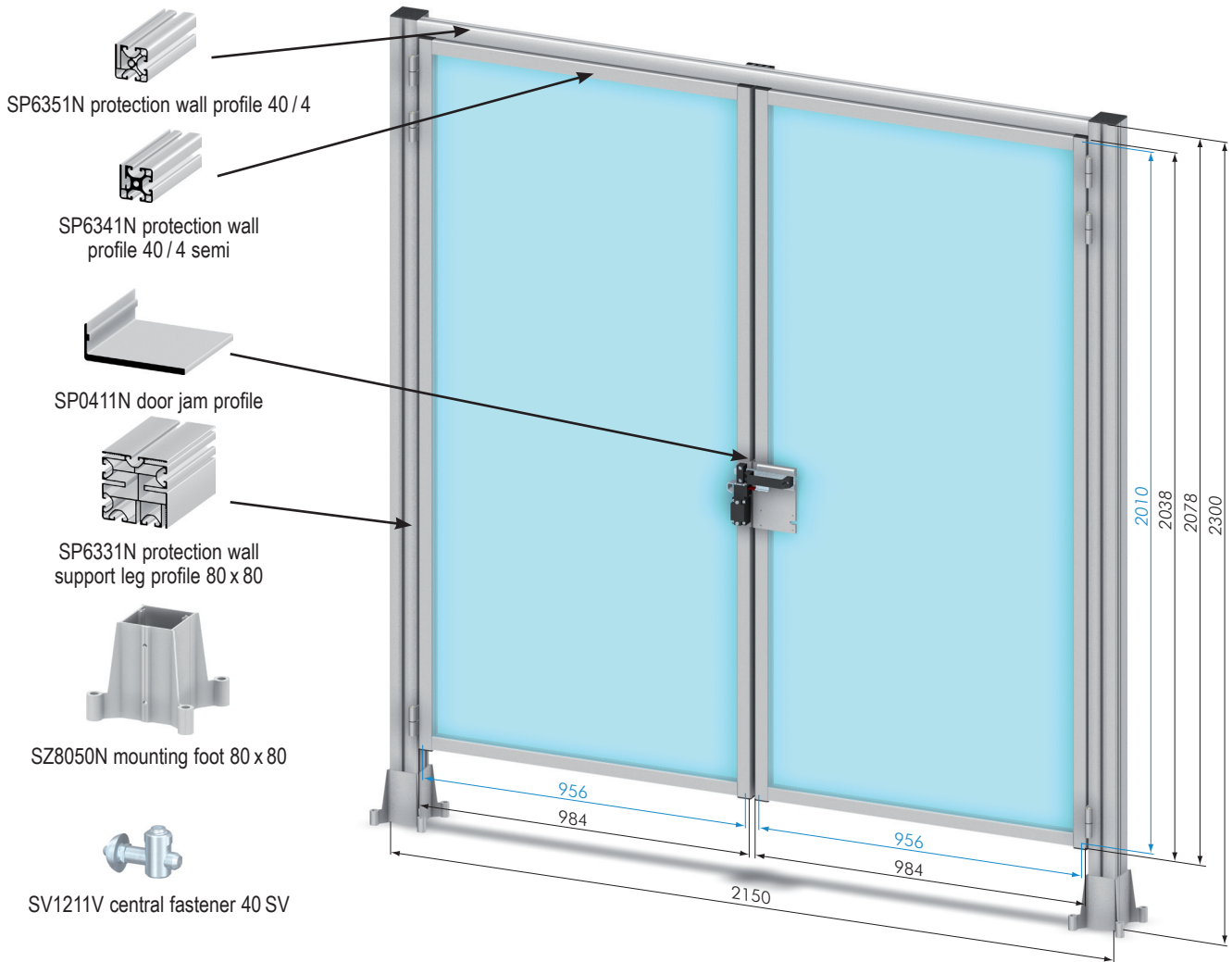

Double Door Elements		
Part No	Description	Total height
SZ8121N	Double Door Element 80 x 80	2300 mm

40

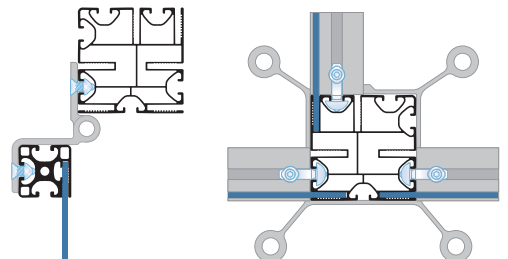

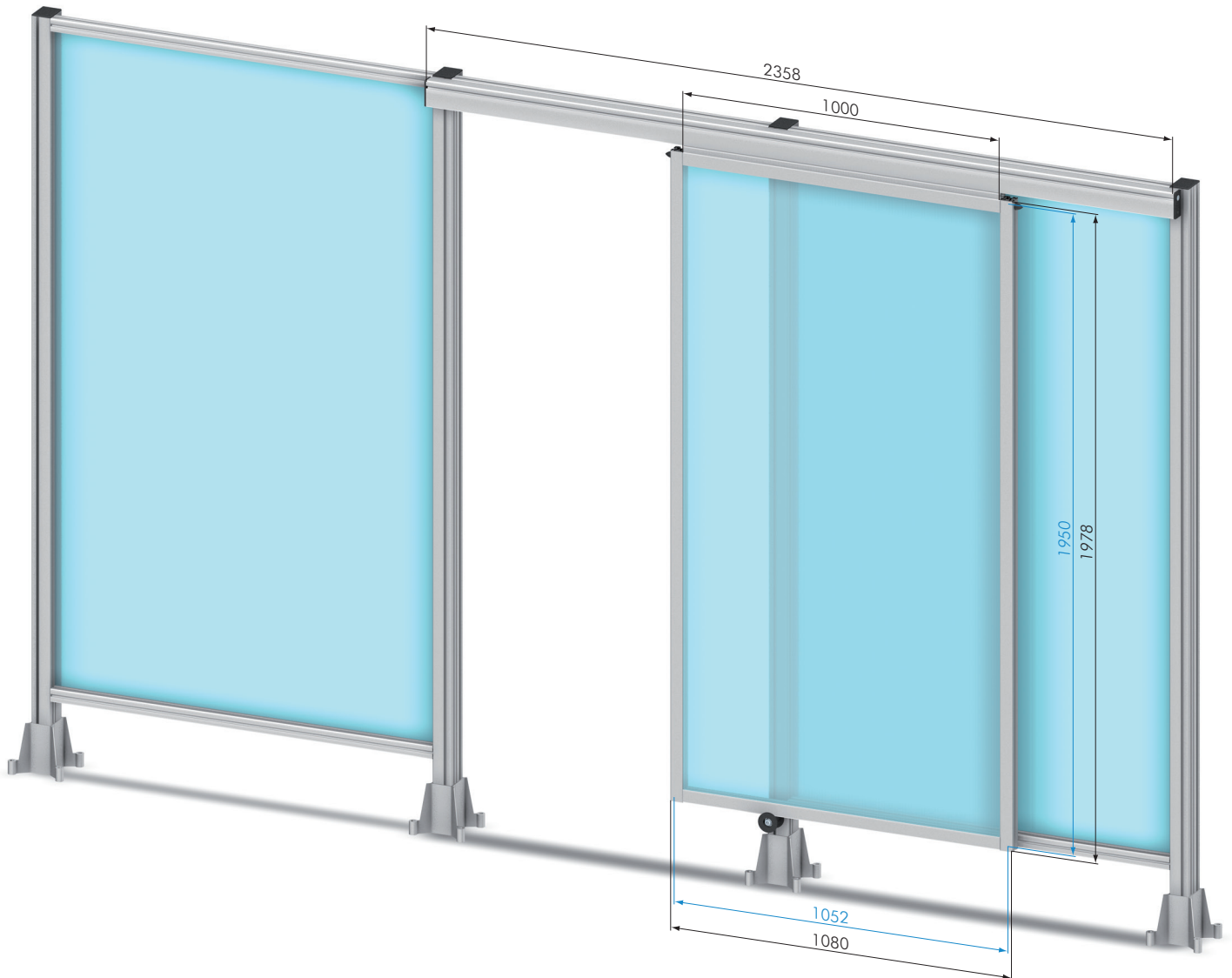

Single Sliding Door Elements

Part No	Description	Total height
SZ8140N	Single Sliding Door Element 60	2300 mm

Supply:

- 1x linear actuator C 40 x 100, L = 2358 mm, with carriage, L = 1000 mm
- 2x SV1301V central fastener 40 GC to connect the carriage to the panel
- 1x door element consisting of:
 - 2x protection wall profile 40 / 4, L = 1000 mm
 - 2x protection wall profile 40 / 4, L = 1978 mm
 - 4x SV1211V central fastener 40 SV
 - 1x sheet material 1052 mm x 1950 mm
- 1x SZ8044S stabilizing roller for supporting sliding doors to vertical profiles



- Not Included:**
- frame elements 60 x 80
 - proximity end stops

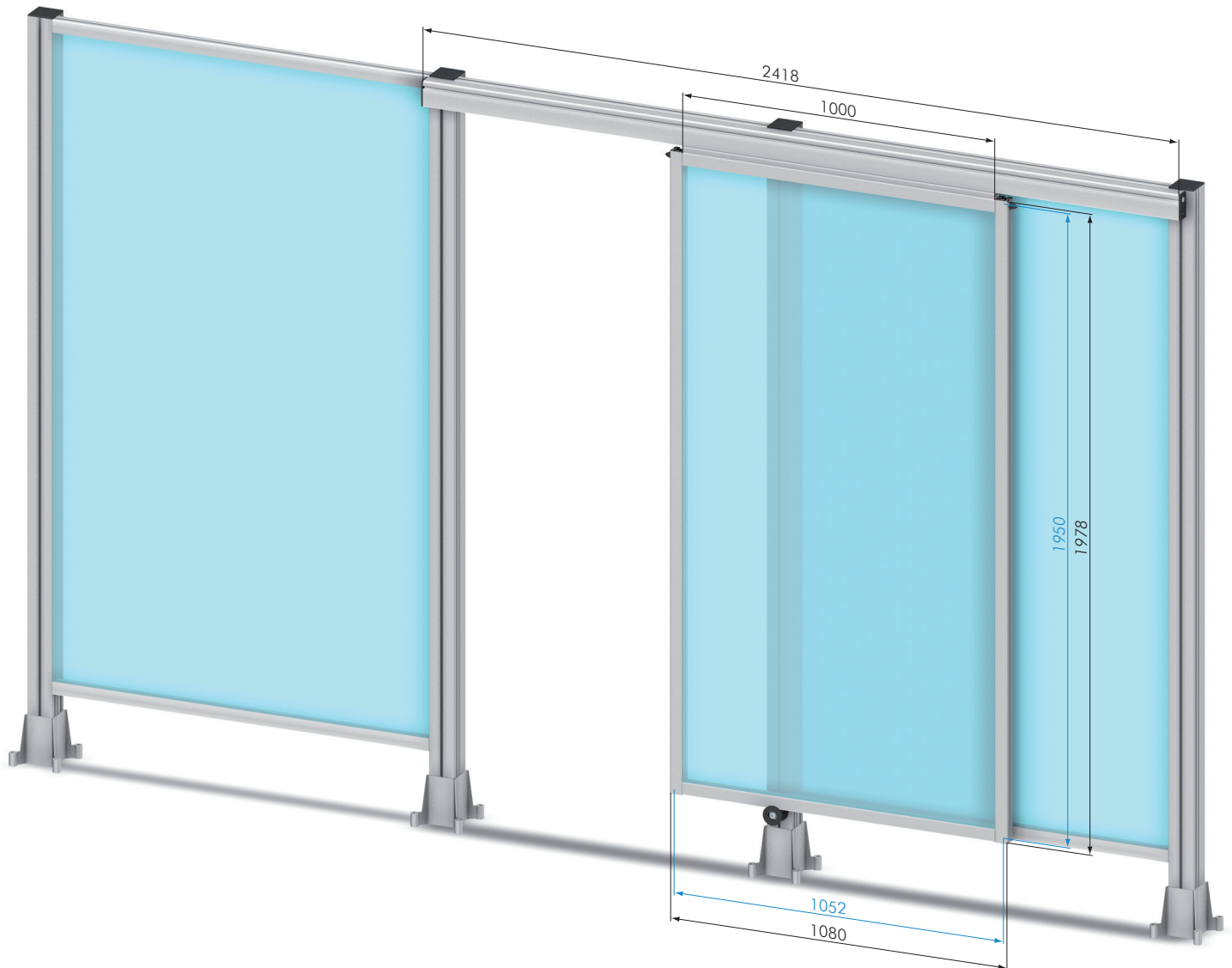

Single Sliding Door Elements		
Part No	Description	Total height
SZ8141N	Single Sliding Door Element 80	2300 mm



Supply:

- 1x linear actuator C 40 x 100, L = 2418 mm, with carriage, L = 1000 mm
- 2x SV1301V central fastener 40 GC to connect the carriage to the panel
- 1x door element consisting of:
 - 2x protection wall profile 40 / 4, L = 1000 mm
 - 2x protection wall profile 40 / 4, L = 1978 mm
 - 4x SV1211V central fastener 40 SV
 - 1x sheet material 1052 mm x 1950 mm
- 1x SZ8044S stabilizing roller for supporting sliding doors to vertical profiles

- Not Included:**
- frame elements 80 x 80
 - proximity end stops

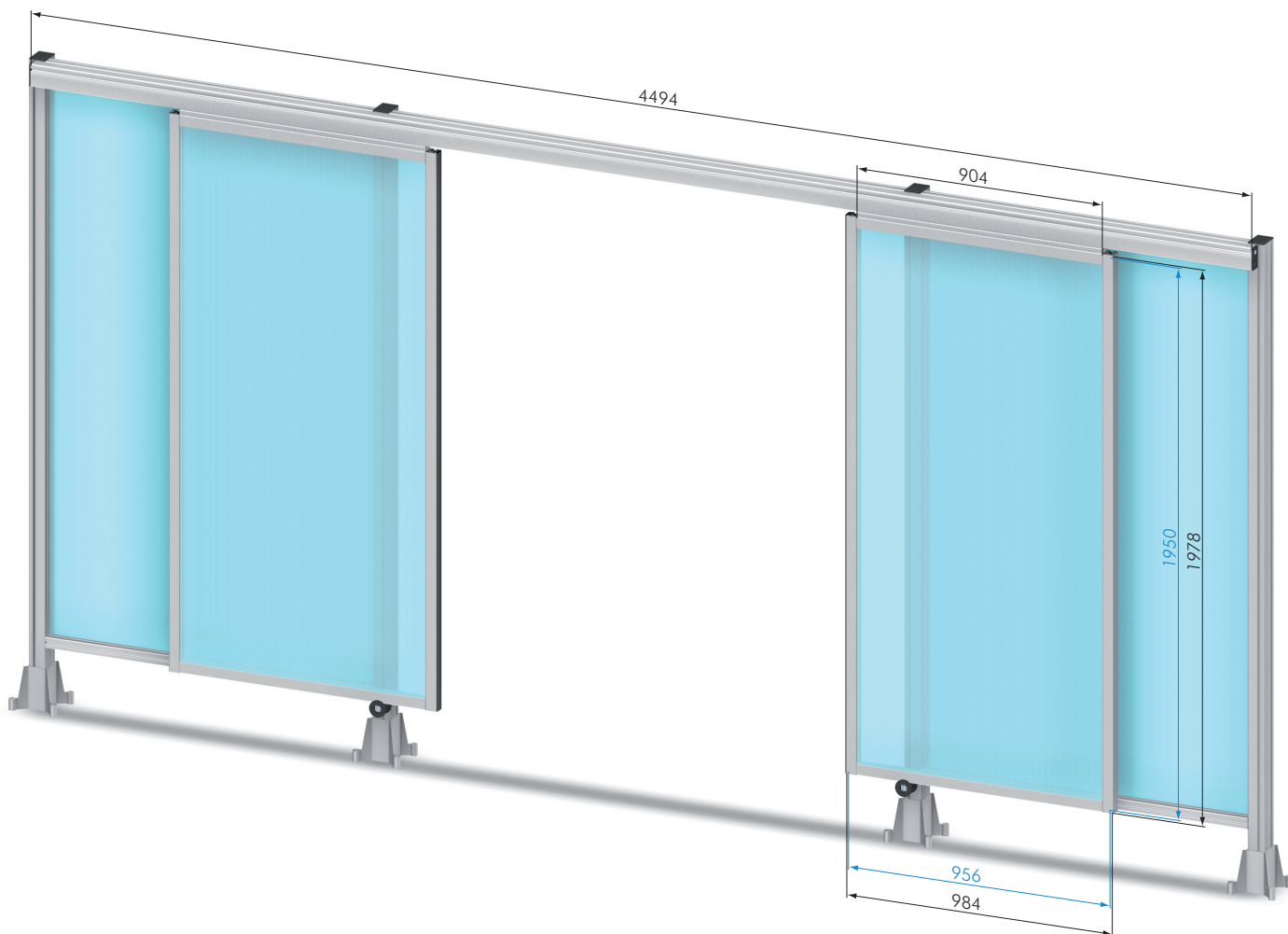

Double Sliding Door Elements		
Part No	Description	
SZ8142N	Double Sliding Door Element 60	2300 mm



Supply:

- 1x linear actuator C 40 x 100, L = 4494 mm, with carriage, L = 904 mm
- 2x SV1301V central fastener 40 GC to connect the carriage to the panel
- 2x door element consisting of:
 - 2x protection wall profile 40 / 4, L = 904 mm
 - 2x protection wall profile 40 / 4, L = 1978 mm
 - 4x SV1211V central fastener 40 SV
 - 1x sheet material 956 mm x 1950 mm
 - 1x SZ1910S rubber cover 32 x 4, L = 1978 mm
- 2x SZ8044S stabilizing roller for supporting sliding doors to vertical profiles

Not Included: • frame elements 60 x 80

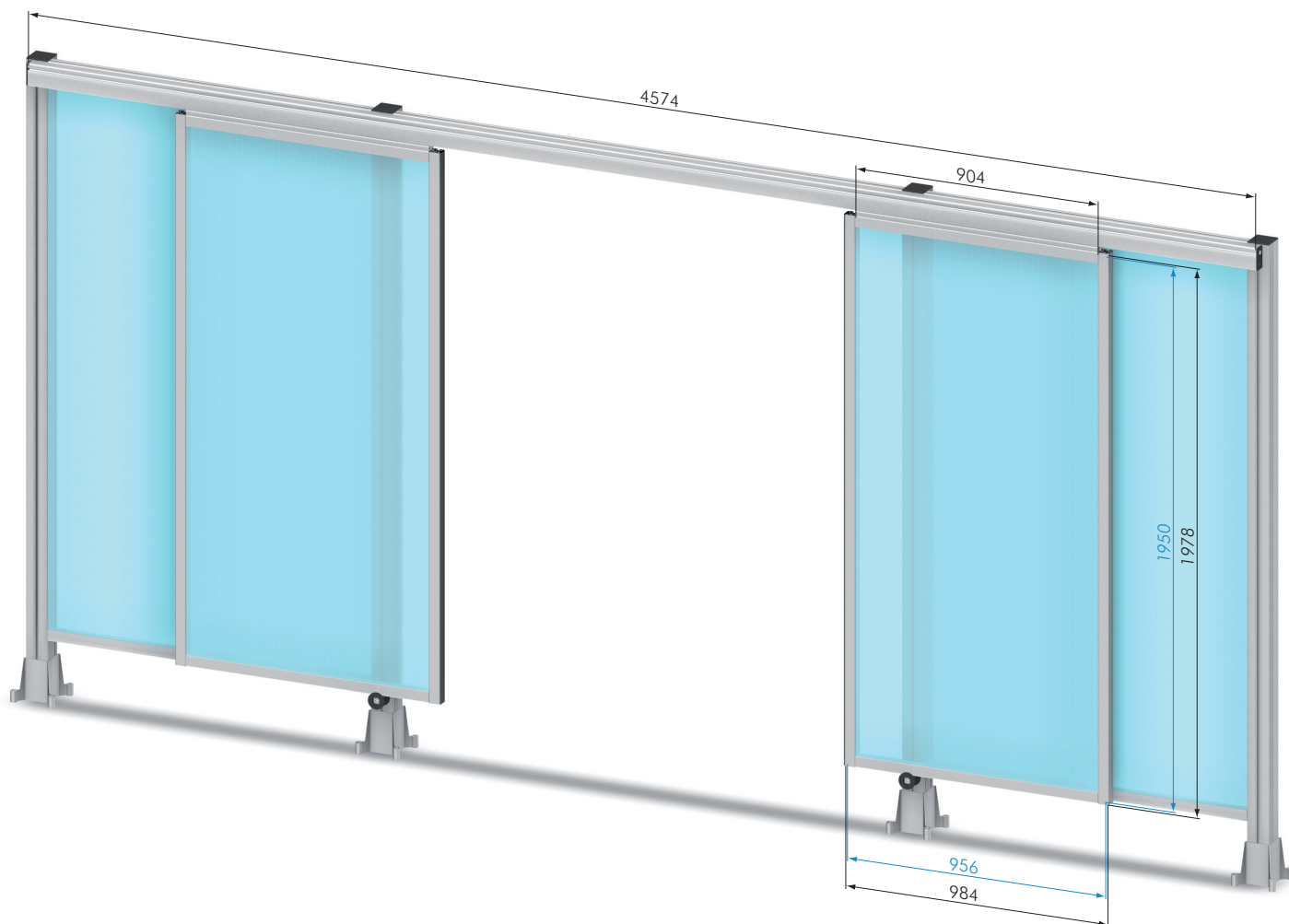

Double Sliding Door Elements		
Part No	Description	Total height
SZ8143N	Double Sliding Door Element 80	2300 mm



Supply:

- 1x linear actuator C 40 x 100, L = 4574 mm, with carriage, L = 904 mm
- 2x SV1301V central fastener 40 GC to connect the carriage to the panel
- 2x door element consisting of:
 - 2x protection wall profile 40 / 4, L = 904 mm
 - 2x protection wall profile 40 / 4, L = 1978 mm
 - 4x SV1211V central fastener 40 SV
 - 1x sheet material 956 mm x 1950 mm
 - 1x SZ1910S rubber cover 32 x 4, L = 1978 mm
- 2x SZ8044S stabilizing roller for supporting sliding doors to vertical profiles

Not Included: • frame elements 80 x 80

Paletti catalogs available on <https://paletti-group.com/media-center/>



Paletti Profilsysteme GmbH & Co. KG

Gewerbepark Meißen 17
D - 32423 Minden

+ 49 (5 71) 38 73 03 - 0
sales@paletti-group.com
www.paletti-group.com

General terms and conditions:
<https://paletti-group.com/agb/>

Concept, Design, Realization and Photos

Every effort has been made to ensure that the information in this product overview is accurate at the time of issues. Nevertheless Paletti cannot accept liability in respect of any errors or omissions herein. Reproduction, including extracts, is permitted only with our written consent. Changes, in the sense of technical improvements, reserved.

© 2023 Paletti Profilsysteme GmbH & Co. KG

